



USER MANUAL

Beamage Series | USB 3.0 Beam Profiling Cameras

WARRANTY

First Year Warranty

The Gentec-EO Beamage series beam profiler carries a one-year warranty (from date of shipment) against material and/or workmanship defects, when used under normal operating conditions. The warranty does not cover damages related to battery leakage or misuse.

Gentec-EO Inc. will repair or replace, at Gentec-EO Inc.'s option, any Beamage that proves to be defective during the warranty period, except in the case of product misuse.

Any attempt by an unauthorized person to alter or repair the product voids the warranty.

The manufacturer is not liable for consequential damages of any kind.

Contacting Gentec Electro-Optics Inc.

In case of malfunction, contact your local Gentec-EO distributor or nearest Gentec-EO Inc. office to obtain a return authorization number. The material should be returned to:

Gentec Electro-Optics, Inc.
445, St-Jean-Baptiste, Suite 160
Québec, QC
Canada, G2E 5N7

Tel: (418) 651-8003
Fax: (418) 651-1174
E-mail: service@gentec-eo.com
Website: gentec-eo.com

CLAIMS

To obtain warranty service, contact your nearest Gentec-EO agent or send the product, with a description of the problem, and prepaid transportation and insurance, to the nearest Gentec-EO agent. Gentec-EO Inc. assumes no risk for damage during transit. Gentec-EO Inc. will, at its option, repair or replace the defective product free of charge or refund your purchase price. However, if Gentec-EO Inc. determines that the failure is caused by misuse, alterations, accident or abnormal conditions of operation or handling, it would therefore not be covered by the warranty.

SAFETY INFORMATION

Do not use a Beamage if the device or the detector looks damaged, or if you suspect that a Beamage is not operating properly.

Note: This equipment has been tested and found to comply with the limits for a Class A digital device, pursuant to part 15 of the FCC Rules. These limits are designed to provide reasonable protection against harmful interference in a residential installation. This equipment generates, uses, and can radiate radio frequency energy. If not installed and used in accordance with the instructions, it may cause harmful interference to radio communications. However, there is no guarantee that interference will not occur in a particular installation. If this equipment does cause harmful interference to radio or television reception, which can be determined by turning the equipment off and on, try to correct the interference by taking one or more of the following steps:

- Reorient or relocate the receiving antenna.
- Increase the distance between the equipment and receiver.
- Connect the equipment to an outlet that is on a different circuit than the receiver.
- Consult the dealer or an experienced radio/TV technician for help.

Caution: Changes or modifications not expressly approved in writing by Gentec-EO Inc. may void the user's authority to operate this equipment.

SYMBOLS

The following international symbols are used in this manual:



Refer to the manual for specific Warning or Caution information to avoid any damage to the product.



DC, Direct Current

TABLE OF CONTENTS

1.	BEAMAGE SERIES – USB 3.0 BEAM PROFILING CAMERAS	6
1.1.	INCLUDED WITH YOUR BEAMAGE CAMERA.....	6
1.2.	INTRODUCTION.....	6
1.3.	SPECIFICATIONS	7
1.4.	MECHANICAL DESCRIPTION.....	11
1.5.	SPECTRAL CURVES	15
2.	QUICK START PROCEDURE.....	18
3.	USER INTERFACE.....	20
3.1.	MAIN CONTROLS.....	21
3.2.	MULTIPLE BEAMAGE MODE	21
3.3.	CAPTURE CONTROLS	22
3.3.1.	<i>Camera Status</i>	22
3.3.2.	<i>Disconnect Camera</i>	23
3.3.3.	<i>Capture</i>	23
3.3.4.	<i>Subtract Background</i>	24
3.4.	BUFFER CONTROLS	27
3.4.1.	<i>Image Index</i>	27
3.4.2.	<i>Exposure Time</i>	27
3.4.3.	<i>Video Trigger</i>	28
3.4.4.	<i>Previous and Next Image</i>	29
3.4.5.	<i>Clear Buffer</i>	29
3.4.6.	<i>Animate</i>	29
3.4.7.	<i>Buffer Size</i>	29
3.5.	COMPUTATIONS	29
3.5.1.	<i>Filters</i>	30
3.5.2.	<i>Normalize</i>	31
3.5.3.	<i>Trigger</i>	32
3.6.	FILE CONTROLS	32
3.6.1.	<i>Open</i>	32
3.6.2.	<i>Save Current Image</i>	33
3.6.3.	<i>Save All Images in Buffer</i>	33
3.6.4.	<i>Start Data Acquisition</i>	34
3.6.5.	<i>Print Report</i>	35
3.7.	STARTUP CONFIG CONTROLS	39
3.7.1.	<i>Settings Buttons</i>	39
3.8.	ADVANCED COMPUTATIONS	40
3.8.1.	<i>Show/Hide Options</i>	40
3.8.2.	<i>Divergence</i>	41
3.8.3.	<i>Relative Position</i>	41
3.8.4.	<i>Camera Lens Calibration</i>	41
3.8.5.	<i>Fixed Crosshair</i>	42
3.8.6.	<i>Pipeline</i>	42
3.8.7.	<i>2D High Resolution</i>	42
3.9.	BEAMAGE-M2 MODE	43
3.10.	M2 FILE	43
3.11.	SOFTWARE INFO	43
3.11.1.	<i>Color Legend</i>	43
3.11.2.	<i>Help</i>	45
4.	HOME AND SETUP PANELS	47
4.1.	HOME.....	48
4.1.1.	<i>Main Controls</i>	49
4.1.2.	<i>Measurements</i>	49
4.2.	SETUP.....	52
4.2.1.	<i>Exposure Time</i>	53

- 4.2.2. *Image Orientation* 53
- 4.2.3. *Image Averaging* 54
- 4.2.4. *Active Area* 54
- 4.2.5. *Pixel Addressing*..... 54
- 4.2.6. *Gain* 55
- 4.2.7. *ADC Level* 55
- 4.2.8. *Pixel Multiplication Factor (PMF)*..... 55
- 4.3. DATA ACQUISITION..... 56
- 4.4. DIVERGENCE 58
- 4.5. RELATIVE POSITION 60
 - 4.5.1. *Setup* 60
 - 4.5.2. *Measurements*..... 61
- 4.6. CAMERA LENS 62
- 4.7. FIXED CROSSHAIR 63
 - 4.7.1. *Center Setup* 63
 - 4.7.2. *Orientation Setup* 67
- 5. DISPLAY PANEL..... 68**
 - 5.1. 3D DISPLAY..... 68
 - 5.1.1. *3D Display: Controls*..... 69
 - 5.2. 2D DISPLAY..... 70
 - KEYBOARD CONTROLS:** 71
 - 5.2.1. *2D Display: Controls*..... 71
 - 5.3. CROSSHAIR DISPLAY..... 72
 - 5.3.1. *Crosshair Display: Controls*..... 72
 - 5.3.2. *Gaussian Fit* 73
 - 5.4. BEAM TRACKING DISPLAY 74
 - 5.4.1. *Beam Tracking Display: Controls*..... 75
- 6. M² MODE 76**
- 7. THIRD PARTY COMMANDS 77**
 - 7.1. PC-BEAMAGE LABVIEW VIS AND .NET COMMANDS..... 77
 - 7.2. LABVIEW EXAMPLE 82
 - 7.3. .NET EXAMPLE..... 84
- 8. TROUBLESHOOTING AND TIPS 86**
- 9. DECLARATION OF CONFORMITY 91**
- 10. UKCA DECLARATION OF CONFORMITY 92**
- APPENDIX A. ISO11146 AND ISO11670 DEFINITIONS 93**
- APPENDIX B. M² QUALITY FACTOR THEORY 96**
 - Understanding the M² Factor*..... 96
 - Propagation Parameters*..... 96
 - Practical Measurement* 98
- APPENDIX C. PC-BEAMAGE SOFTWARE 99**
- APPENDIX D. BEAMAGE DRIVER INSTALLATION QUICK GUIDE 101**
- APPENDIX E. BEAMAGE FIRMWARE INSTALLATION QUICK GUIDE 105**
- APPENDIX F. PC-BEAMAGE UPDATES..... 107**
- APPENDIX G. RECYCLING AND SEPARATION PROCEDURE FOR WEEE..... 112**
- APPENDIX H. COMPLETE LIST OF SAVED SETTINGS..... 113**
- APPENDIX I. SATURATION LIMIT FOR BEAMAGE WITH ND4.0 FILTER 114**

1. BEAMAGE SERIES – USB 3.0 BEAM PROFILING CAMERAS

1.1. INCLUDED WITH YOUR BEAMAGE CAMERA

The following items are included with BEAMAGE:

Description	Part name	Part number
Beamage series camera with ND4.0 filter mounted	Beamage	See website
3 m USB-3 cable	B3-USB	103642
Compliance certificate		
SMA-BNC adapter		103641
Transport case		
USB-A to USB-C adapter	USBA-C	205915

The following items are included with BEAMAGE-4M-FOCUS:

Description	Part name	Part number
Beamage FOCUS camera	Beamage-4M-FOCUS	203191
T-mount to SM2 adaptor (mounted)		
SM2 ND-4.0 filter (mounted)	ND4.0-FOCUS	203407
3 m USB-3 cable	B3-USB	103642
Compliance certificate		
SMA-BNC adapter		103641
Transport case		
USB-A to USB-C adapter	USBA-C	205915

The following items can be purchased separately:

Description	Part name	Part number
UV Converter	BSF	See website
IR Adaptor	IR Adaptor	201061
Camera lens	CL-25 CL-50	202343 202344
UV filter	UG11-UV	202602
IR filter	B3-IR-FILTER	202855
Beam attenuator (See BA series)	BA Series	See website
Stackable ND filters (0.5; 1.0; 2.0; 3.0; 4.0 & 5.0)	ND filters	See website
3 m USB-3 cable	B3-USB	103642
Powered USB-3.0 hub	USB3.0-HUB	202829
Stand	STAND-D-233	200428
USB-A to USB-C adapter	USBA-C	205915

1.2. INTRODUCTION

Gentec-EO introduces the Beamage beam profiler series. Its sleek and thin design allows the Beamage to fit between tight optical components. Its USB 3.0 connection and improved algorithm allows very fast frame rates. The Beamage-3.0 2.2 MPixel CMOS sensor has a large $\frac{2}{3}$ " optical format with a small 5.5 μm pixel pitch allowing high resolution on large beams. For larger beams, the Beamage-4M impressive 4.2 MPixel CMOS sensor and its very large 1" optical format is the ideal solution. Both beam profilers are available in the IR version allowing measurements between 1495 and 1595 nm. The newest member of this series is the Beamage-4M-FOCUS, specifically designed for extra-large beams. Its bounded fiber optic taper

extends the sensor surface to 20.5 x 20.5 mm effective size. Most importantly the innovative and improved PC-Beamage software is simple and intuitive to any new or expert beam profiling user.

All screenshots in this manual with the words "Beamage-3.0" can be interpreted as "Beamage-4M".

1.3. SPECIFICATIONS

The following specifications are based on a one-year calibration cycle, an operating temperature of 18 to 28°C (64 to 82 F) and a relative humidity not exceeding 80%.

	Beamage-3.0	Beamage-3.0-IR	Beamage-4M	Beamage-4M-IR	Beamage-4M-FOCUS
	Sensor				
Sensor Technology	CMOS without coverglass				
Sensor Size	11.3 x 6.0 mm		11.3 x 11.3 mm		20.5 x 20.5 mm effective size ¹
Sensor Area	0.67 cm ²		1.28 cm ²		4.2 cm ² effective optical aperture
Pixel Count	2.2 MPixels		4.2 MPixels		
Pixel H x V	2048 x 1088		2048 x 2048		
Optical Format	$\frac{2}{3}$ "		1"		
Pixel Pitch of Sensor² (Pixel Size)	5.5 μ m				
Shutter Type	Global				
Wavelength Range	350 - 1150 nm	1495 - 1595 nm	350 - 1150 nm	1495 - 1595 nm	350 - 1150 nm
Minimum Measurable Beam (ISO)	55 μ m	70 μ m ³	55 μ m	70 μ m ¹	120 μ m
ADC	12 bit (default) or 10 bit				

¹ With Pixel Multiplication Factor 1.8

² For -IR models, optical resolution is larger (7 μ m) because of the Point Spread Function (PSF) of the Phosphor Coating. For the -FOCUS model, optical resolution is larger (12 μ m) because of the Pixel Multiplication Factor (PMF) and of the Point Spread Function (PSF) of the bound fiber optic bundle.

³ Minimum measurable beam is larger because of the Point Spread Function (PSF) of the Phosphor Coating (for the -IR models) and of the bound fiber optic bundle (for the -FOCUS model)

Frame Rate	3.0 Sensor		4M Sensor		
	12 bit (fps)	Active Area	12 bit (fps)	10 bit (fps)	Active Area
	11.0	2048 x 1088	6.0	10.7	2048 x 2048
	20.0	2048 x 544	9.1	13.0	1024 x 1024
	32.0	256 x 256	10.7	16.0	768 x 768
			12.8	16.2	512 x 512
			16.0	16.9	256 x 256
			16.2	21.3	128 x 128
		21.3	21.6	50 x 50 (Custom)	
RMS noise	1000:1 (60 dB)				
Minimum and Maximum Exposure Times	0.06 to 200 ms				
External Trigger	SMA connector 1.1 volts to 24 volts, the rise edge response time is 300 ns Trigger signal pulse width: min: 300 ns SMA to BNC adaptor provided (103641)				
Cable	USB-A (computer) to USB Micro-B (camera) 3.0 m length USB-A to USB-C adapter				

Damage Thresholds	
Maximum Average Power	1 W with ND filter
Maximum Power Density (1064 nm, CW)	10 W/cm ² with ND4.0 filter
Maximum Energy Density (1064 nm, 10 ns Pulsed)	0.1 J/cm ² for ND4.0 filter only (30 µJ/cm ² on sensor)

Physical Characteristics		
Dimensions	61 H x 81.1W x 19.7D mm	61 H x 81.1W x 46.5D mm
Weight	138 g	235 g
Distance from front of case to sensor	7.8 mm ± 1 mm	
Default Attenuation	ND 4.0 (Beamage-3.0, -4M and -4M-FOCUS)	
Mounting Holes	1/4"-20 2 mounting locations (see Figure 1-1)	

Measured and Displayed Parameters	
Displays	3D, 2D, XY (crosshair), Beam Tracking, M ² Curves
Beam Diameter Definition	4 Sigma (ISO) - ISO-11146-1:2005 FWHM along crosshair (50%) 1/e ² along crosshair (13.5%) 86% effective diameter (D86) Custom along crosshair (%)
Beam Center Definition	Centroid - ISO-11146-1:2005 First Encountered Peak
Displayed Measurements	Beam Diameter d _{0x} and d _{0y} Effective Diameter Ellipticity Orientation Centroid X and Y Peak X and Y Peak Saturation Level Peak to Average Ratio X and Y Divergence Fitted Gaussian equations Roughness fit along crosshairs Gaussian fit along crosshairs Mean Centroid Position Azimuth Beam Position Stability M ² Quality Measurement
Setup Options	Exposure Time (auto or manual) Image Orientation (rotation and flip) Image Averaging (temporal filter) Active Area Pixel Addressing Gain ADC Level Magnifying Lens
Processing Option	Background Subtraction Area Filters (triangular and flat spatial filters) Normalized Display Trigger
Buffer	Buffer size from 1 to 128 frames Possibility to animate stored frames
File options	Save 1 or all images in buffer Save in native format, text format, or binary format Load native format files Default and custom print report Save 3D or 2D image in bitmap format Save crosshairs in text format Data Acquisition of measurements in text format and in native format

	PC Requirements
USB Port	USB 3.0 port for optimal performance USB 2.0 port
Operating System Compatibility	Windows 11 Windows 10 Windows 8
Average RAM Allocation	500 MB Up to 1250 MB for 128 images in buffer
Recommended Requirements	4 GB RAM minimum 8GB RAM for optimal performance Intel i series processors (i3, i5, i7) or equivalent for optimal performance, other processors will have lower specifications. i7 for optimal performance A computer with a SSD drive. Beamage-3.0 is a new and a high end product. It needs an equally recent high end computer to work. Computer hardware must be from 2015 or after. No computer or parts bought before 2015 will be supported Laptop computers need to be powered and any power saving settings must be disabled when using the Beamage. For this reason, we recommend a desktop computer over a laptop computer.
For Optimal Performance	Close all programs except PC-Beamage; Keep a minimum of 1 GB RAM free when running PC-Beamage; Keep a minimum of 50% of free CPU power when running PC-Beamage Use an Image Buffer of 1
For Faster Frame Rate	Use a USB-3.0 port; Use a computer with high performances (refer to PC Requirements); Use Windows 10 or 11; Follow the PC recommendations for optimal performance (refer to section 1.2) Do not use Filters (refer to 3.5.1); Do not use Image Averaging (refer to 4.2.3); For a large beam, use Pixel Addressing (refer to 4.2.5); For a small beam, use an Active Area as small as possible (3 times the beam diameter, refer to 4.2.4); Make sure you have a short and manual exposure time; Do not stream multiple Beamage units simultaneously. Close any other software on your computer. Make a background subtraction; Use 1/e2 beam diameter definition with 0 degree orientation; Deactivate 2D High Resolution (Advanced tab); Have a minimum of 30% of hard drive space available; Unplug any other peripheral device on your computer; Disable any power saving settings on your computer.
Multi Camera Recommendation	When working with more than one camera, we strongly recommend using one USB3.0 port per camera and a recent high end computer for optimal performance
Internet Upgrades	Downloadable at www.gentec-eo.com/downloads

1.4. MECHANICAL DESCRIPTION

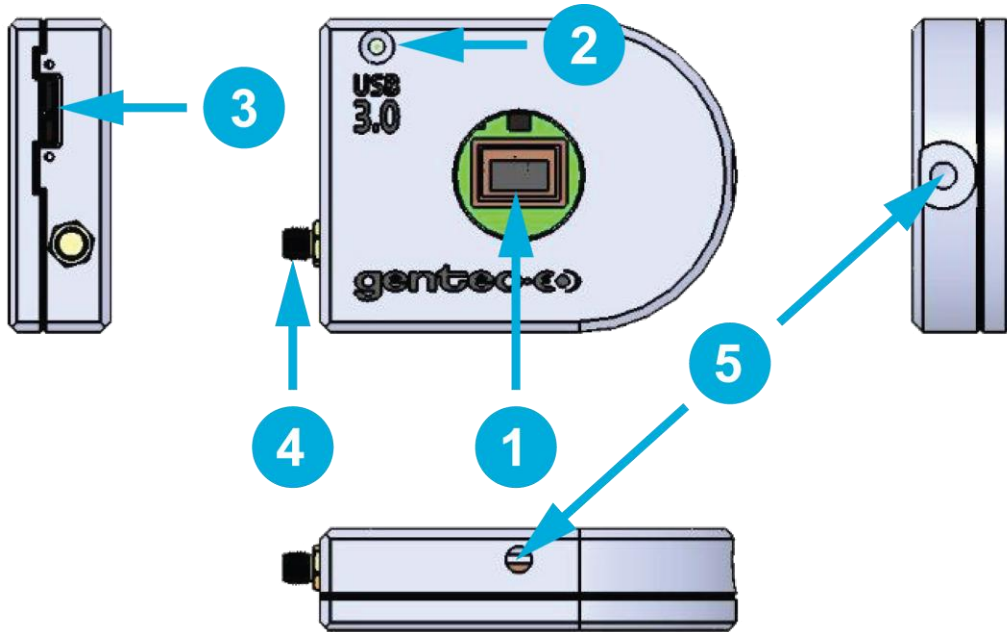

Figure 1-1 Beamage series front and side views

1

Aperture

The aperture of the Beamage and the screw threads are C-MOUNT, allowing easy connectivity with optical accessories such as attenuation filters, UV converters or lenses. The sensor is centered with the aperture's center.



Add or remove accessories in a clean room or very clean environment, and position the front cover of the camera downwards when doing so.

2

LED Indicator

The LED indicates if the Beamage has been detected by the computer and if it is currently streaming.

3

USB 3.0 Connector

The USB 3.0 connector is now more rugged with its threaded holes. Please note that only USB 3.0 compliant cables can be used with the Beamage. Do not use at any time low-cost USB-3.0 cables. USB 2.0 ports can be used, but it will lower the Beamage speed performance.



In order to ensure reliable and stable communication with a Beamage, precautions must be taken when handling the USB cable and its connector:

- ◆ Connector screws: Screw until it is tight, but be careful not to screw too tight. This could potentially damage the connector.
- ◆ Do not apply pressure on the connector or pull the cable when it is connected.
- ◆ We strongly recommended using the cable provided with the Beamage.
- ◆ The maximum length for a USB-3.0 cable is 3 meters (9 feet and 10 inches). For a longer distance, a good quality repeater is mandatory.
- ◆ Avoid using low-cost USB-3.0 computer expansion card.
- ◆ For optimal performance and stability, do not use any other USB device that communicates intensive data and uses high power current on your USB port when using the Beamage.
- ◆ Disable any power saving settings on your computer. It could reduce the power attribution on the USB port and the Beamage camera needs all the power from the USB-3.0 port to provide a stable communication.

- ◆ For a laptop computer, always power the computer when using the Beamage camera.

4**SMA Connector**

The SMA connector is used to externally trigger the Beamage. A SMA to BNC adaptor is available.

5**Mounting Holes**

$\frac{1}{4}$ "-20 holes are aligned with the sensor's center allowing easy optical alignment.

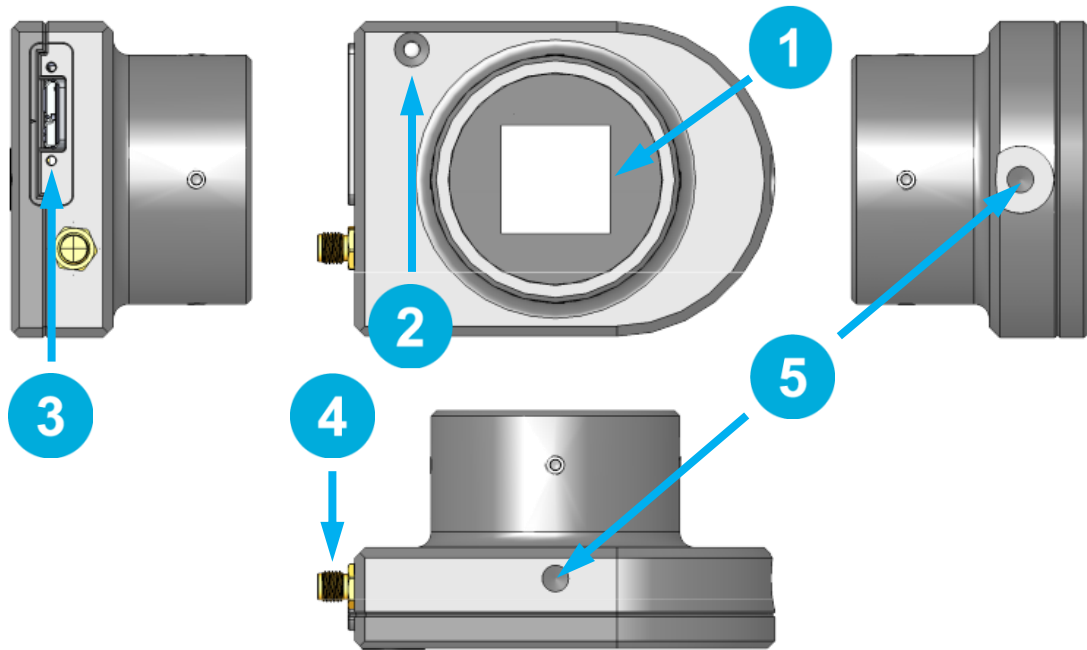

Figure 1-2 Beamage-4M-FOCUS front and side views

1

Aperture

The optical aperture of the Beamage-4M-FOCUS is centered with the T-Mount threads on the front casing. These threads and the included T-Mount to SM2 adaptor allow easy connectivity with optical accessories such as attenuation filters.

2

LED Indicator

The LED indicates if the Beamage has been detected by the computer and if it is currently streaming.

3

USB 3.0 Connector

The USB 3.0 connector is now more rugged with its threaded holes. Please note that only USB 3.0 compliant cables can be used with the Beamage. Do not use at any time low-cost USB-3.0 cables. USB 2.0 ports can be used, but it will lower the Beamage speed performance.



In order to ensure reliable and stable communication with a Beamage, precautions must be taken when handling the USB cable and its connector:

- ◆ Connector screws: Screw until it is tight, but be careful not to screw too tight. This could potentially damage the connector.
- ◆ Do not shake the cable when the Beamage is connected.
- ◆ Do not apply pressure on the connector when it is connected to a Beamage.
- ◆ We strongly recommend using the cable provided with the Beamage.
- ◆ The maximum length for a USB-3.0 cable is 3 meters (9 feet and 10 inches). For a longer distance, a repeater is mandatory.
- ◆ Avoid using low-cost USB-3.0 computer expansion card.
- ◆ For optimal performance and stability, use only the Beamage and do not use any other USB device that communicates intensive data and use high power current on your computer.

- ◆ Disable any power saving settings on your computer, it could reduce the power attribution on the USB port and the Beamage camera needs all the power from the USB-3.0 port to provide a stable communication.
- ◆ For a laptop computer, always power the computer when using the Beamage camera.

4**SMA Connector**

The SMA connector is used to externally trigger the Beamage. An SMA to BNC adaptor is available.

5**Mounting Holes**

1/4"-20 holes are aligned with the sensor's center allowing easy optical alignment.

1.5. SPECTRAL CURVES

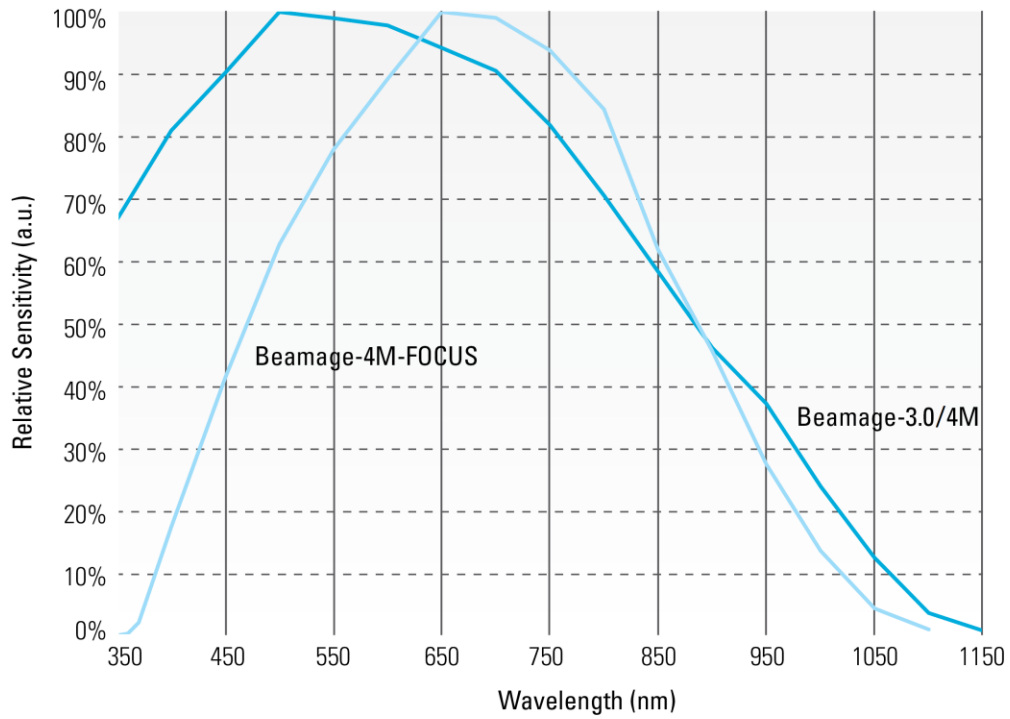

Figure 1-3 Spectral response of the CMOS sensor

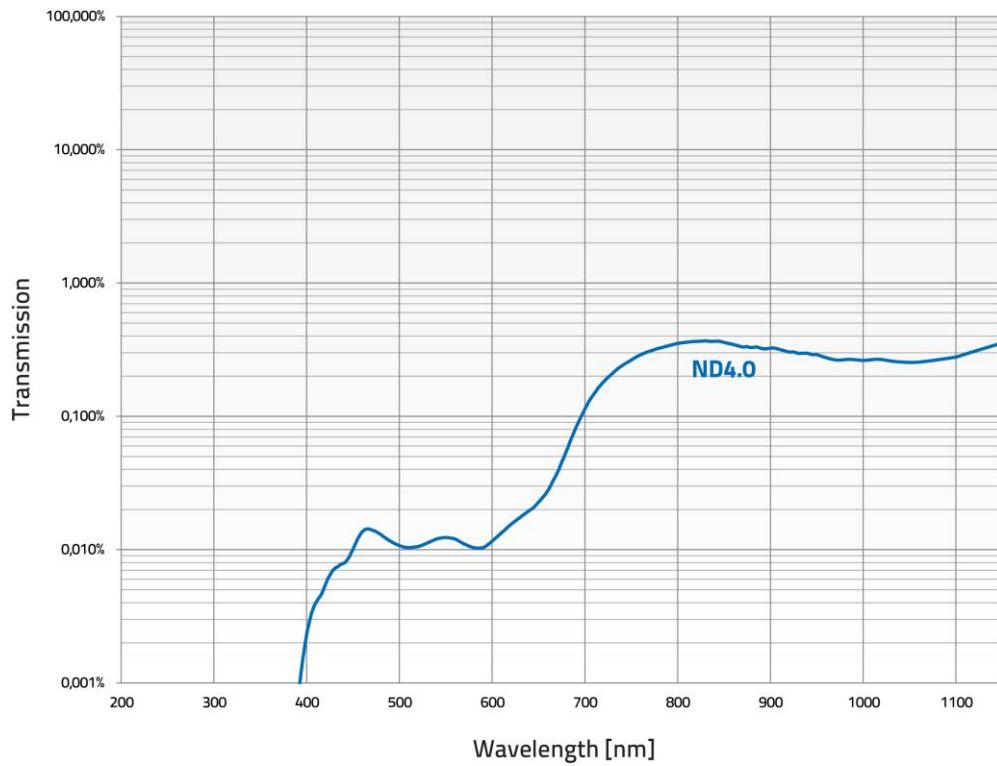

Figure 1-4 Transmission of the ND4.0 filter

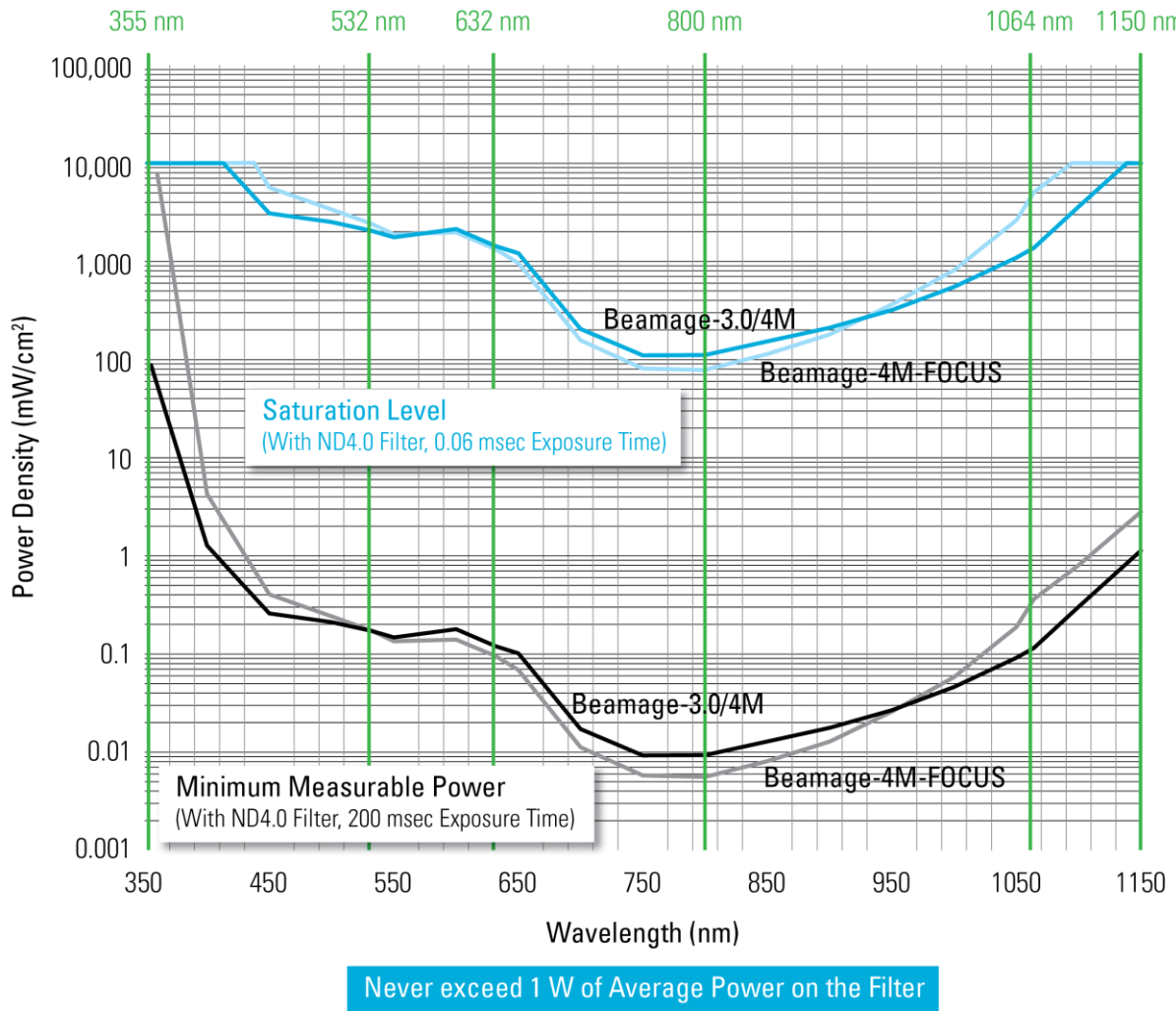

Figure 1-5 Minimum measurable power and saturation power level

Beamage-3.0 and Beamage-4M										
Wavelength	UG11-UV		ND 0.5		ND 4.0		ND5.0		IR Filter	
	Minimum (mW/cm ²)	Saturation (mW/cm ²)	Minimum (mW/cm ²)	Saturation (mW/cm ²)	Minimum (mW/cm ²)	Saturation (mW/cm ²)	Minimum (mW/cm ²)	Saturation (mW/cm ²)	Minimum (mW/cm ²)	Saturation (mW/cm ²)
300 nm	0.0001	0.54								
355 nm			0.00024	3.4						
532 nm			0.000034	0.47	0.15	2000	1.9			
632 nm			0.000035	0.49	0.10	1400	1.2	10000*		
800 nm			0.000037	0.51	0.0080	110	0.042	590		
1064 nm			0.00035	4.8	0.099	1400	0.59	8100		
1150 nm			0.0043	61	0.97	10000*	5.7			
1310 nm									0.55	6900
Beamage-3.0-IR and Beamage-4M-IR										
1550 nm			3.04	520	62.0	10000	176	10000*	0.097	272
Beamage-4M-FOCUS										
355 nm			0.33	4700						
532 nm			0.000039	0.55	0.17	2400	2.2			
632 nm			0.000029	0.41	0.086	1200	0.99	10000*		
800 nm			0.000026	0.36	0.0056	78	0.030	410		
1064 nm			0.0013	18	0.37	5200	2.2			
1150 nm			0.013	175	2.8					

- Minimum power is measured at an exposure time of 200 ms
- Saturation level is measured at an exposure time of 0.06 ms
- Do not exceed 1 W on the ND filter
- For higher densities please refer to the Beamage Accessories User Manual to correctly attenuate your laser

* : Maximum saturation is limited to 10 W/cm² due to the filter's damage threshold. You can request the sensor's maximum saturation intensity by contacting Gentec-EO.

2. QUICK START PROCEDURE

1. Install the PC-Beamage Software.
2. Install the USB Drivers. Make sure to follow the installation instructions (refer to Appendix B).

NOTE: The drivers must be reinstalled with each new software installation. If necessary, update the firmware using the BeamageUpdater file (Refer to Appendix C).

3. Connect the Beamage to a USB3.0 or USB2.0 port.

NOTE: Make sure to secure the USB connector on the Beamage using the set screws. This will ensure a stable communication.



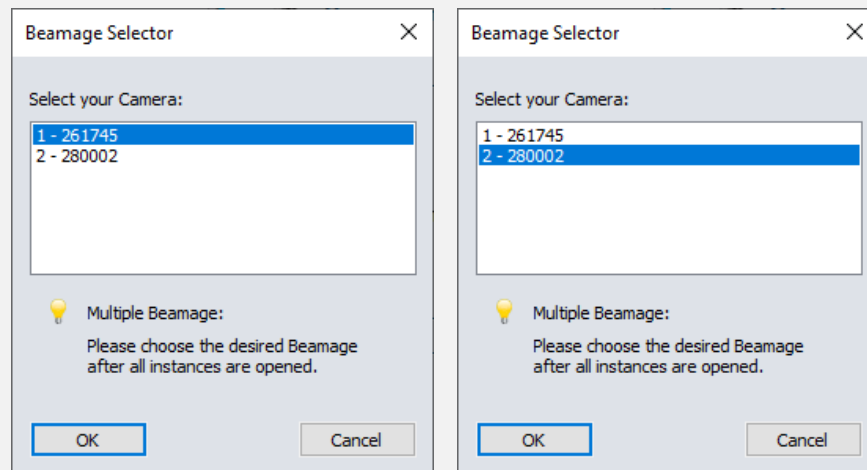

4. Start your laser and align the beam in the aperture of the camera.
5. Start the PC-Beamage software. Select the camera from the list. The green LED button in the **Main Controls** indicates that communication has been established.

NOTE: When using multiple cameras, you need to start multiple instances of the software one by one and then select the desired camera in each. For example, if you have 2 cameras, first open an instance of PC-Beamage and wait for the Beamage Selector dialog. Then, open another instance of PC-Beamage and wait for the Beamage Selector dialog. Then, go back to the first instance and select the appropriate serial number. Finally, go to the second instance and select the remaining camera.

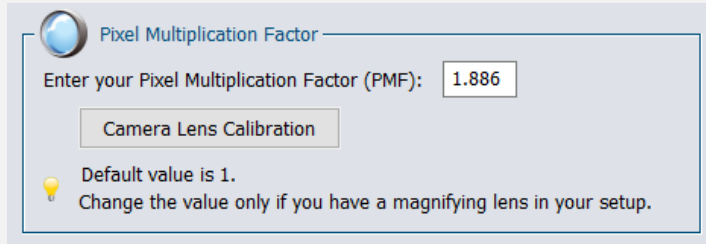

6. For a **Beamage-4M-FOCUS**, enter the **Pixel Multiplication Factor (PMF)** at the bottom of the **Settings** tab. You must enter the PMF for every computer on which the Beamage-4M-FOCUS is used.



7. Press **Start Capture**.
8. Let the **Auto Exposure** algorithm find the correct exposure time. This should take a few seconds. If the exposure time is 200 ms and your beam is underexposed, you need to remove some attenuation. If the exposure time is 0.06 ms and the beam is saturated, you need to add attenuation.
9. Remove the background radiation:
 - a) Click on **Subtract Background**.
 - b) A message box will appear. Once this message appears, block your laser beam and click **OK**
 - c) Once the "Please wait" message disappears, you can unblock your laser beam.
10. The measurements appear in the **Home** tab on the right-hand side.
11. You may choose one of the following display modes from the **Display Panel**:
 - a.  3D Display;
 - b.  2D Display;
 - c.  Crosshair Display;
 - d.  Beam tracking Display.

3. USER INTERFACE

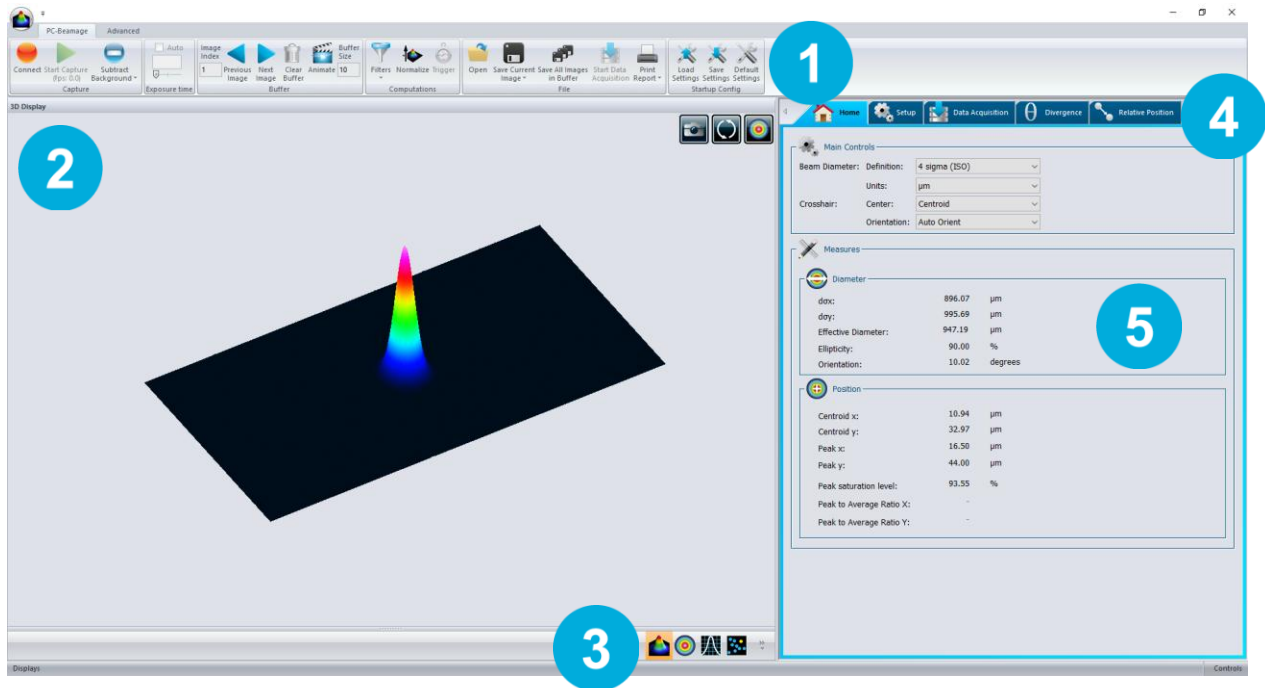

Figure 3-1 PC-Beamage user interface

1

Main Controls

The top portion of the software is in a ribbon format and includes all the main controls. These are grouped by family, including Capture controls, File controls, Startup Config controls, Buffer controls, Data Computation controls (which include a very useful spatial filter and a normalizing function), M2 controls and Information controls.

2

Display Panel

The left-hand side of the software is the display panel. Three displays are available: 3D, 2D, and XY (cross-sectional graphs along the crosshairs).

3

Change Display

At any time, it is possible to change the type of display.

4

Analysis Panel - Tab Selector

Choose between the Home, Setup or Data Acquisition panel tab.

5

Analysis Panel – Controls

The right-hand side of the software contains the Home, Setup and Data Acquisition tabs. The first tab (Home) allows the user to select the type of measurements to be performed, and also shows the resulting measurements of the beam. The second tab (Setup) contains all the measurement parameters, such as the Exposure Time, Image Orientation, Averaging, Active Area, and more. The third tab (Data Acquisition) lets the user specify the desired acquisition parameters.

3.1. MAIN CONTROLS

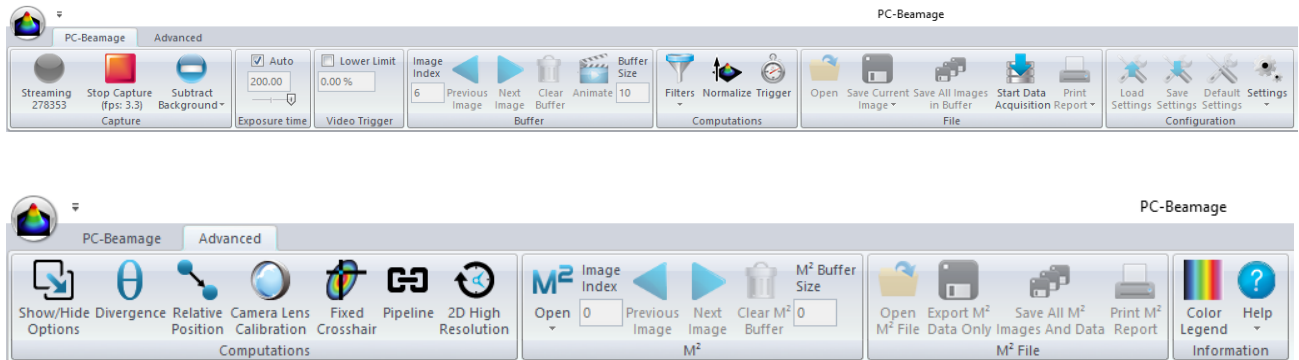

Figure 3-2 Main controls

To give more room to the graphical display and less to the ribbon, you can minimize the ribbon by right-clicking on it and choosing “Minimize the ribbon”. You can retrieve the ribbon at any time by right-clicking on the upper portion of the window and unchecking “Minimize the ribbon”.

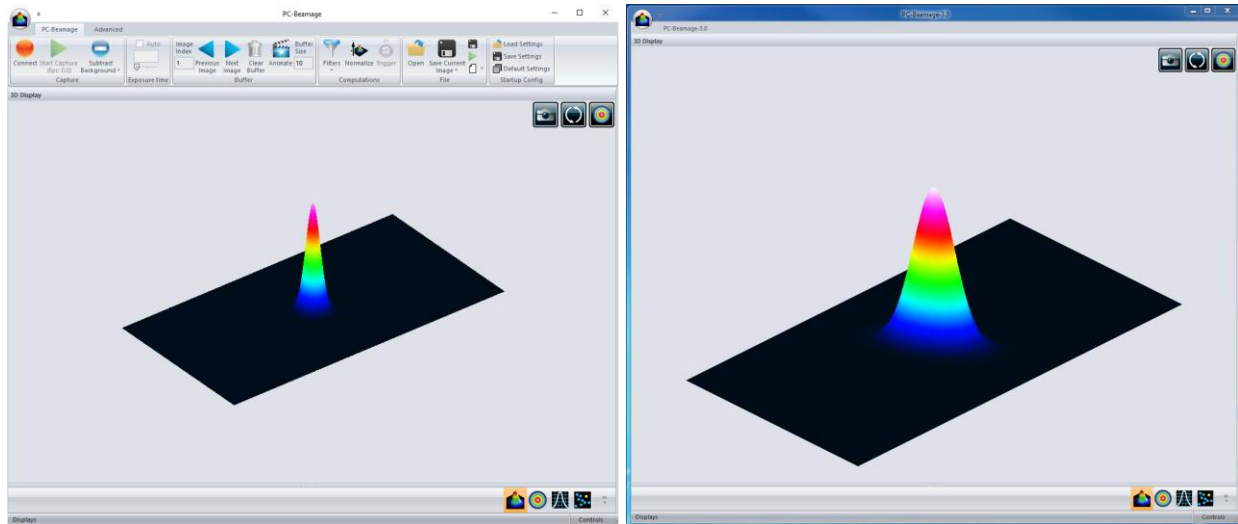

Figure 3-3 PC-Beamage interface with and without the main controls ribbon

3.2. MULTIPLE BEAMAGE MODE

It is possible to connect multiple Beamage units to a single computer. When you start the PC-Beamage, the following window showing all the serial numbers of the connected cameras will appear. If numerous Beamage are connected to the computer, please select the desired camera. To connect to another Beamage simultaneously, you must first start all desired PC-Beamage instances one by one before selecting the desired serial number for each instance. For example, if you have 2 cameras, first open an instance of PC-Beamage and wait for the Beamage Selector dialog. Then, open another instance of PC-Beamage and wait for the Beamage Selector dialog. Then, go back to the first instance and select the appropriate serial number. Then, go back to the second instance and do the same. You can start streaming after all the desired Beamage units have been connected to a PC-Beamage instance.

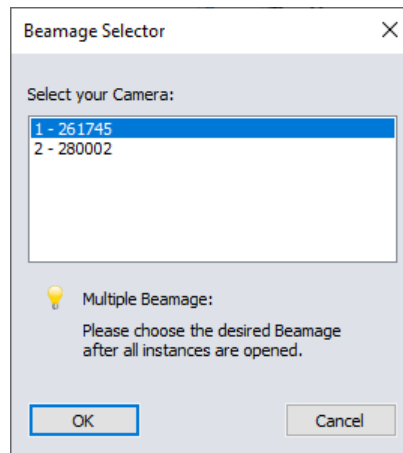

Figure 3-4 Beamage selector for multiple connected cameras



Multiple Beamage beam profilers can be connected to a single computer. However, PC-Beamage does not support multiple cameras at once, so you need to open a new instance of the program for each camera that is connected to your computer.

3.3. CAPTURE CONTROLS

The “*Capture Menu*” displays the Beamage current status, controls the capture, and captures an *average detector background map*.

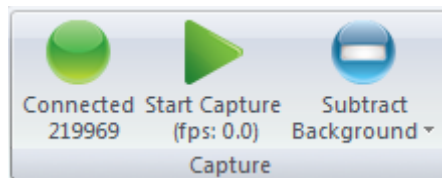

Figure 3-5 Capture controls

3.3.1. Camera Status

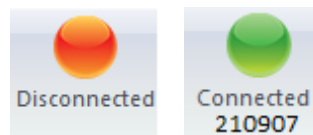

Figure 3-6 Camera status

The software will automatically detect when a Beamage is connected to the computer and it will be indicated in the *Camera Status* with a green button, while a red button indicates that there is no Beamage connected. When the PC-Beamage is capturing an image, the status green button will flash as well as the LED on the Beamage. Each time the pixels are capturing an image, the LED will be off to avoid parasitic lighting from the LED. Note that clicking on this button will not do anything since it is not a control button, but rather a status indicator. It also indicates the serial number of the connected Beamage.

3.3.2. Disconnect Camera

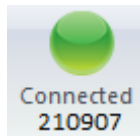

Figure 3- 7 Camera status button

The Beamage camera can be disconnected. When you click on camera status, a message will appear. Click *Yes* to disconnect or *No* to cancel, see Figure 3- 8 Disconnect message.

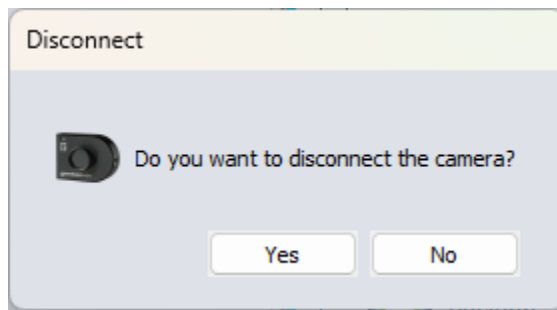

Figure 3- 8 Disconnect message



Tip

Once your camera is disconnected, you can change to another camera without restarting PC-Beamage.

3.3.3. Capture

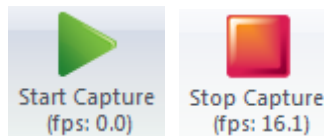

Figure 3-9 Capture button

To start capturing images with the Beamage, click on the “*Start Capture*”. If no Beamage is connected to the computer or if the “*Animate*” mode (refer to section 3.4.6) is on, this button will not be available. Once the Beamage starts streaming, the frame rate will be displayed below the button in frames per second (fps). This value includes the acquisition and computation time.

If you are using a laptop, we recommend to use the software only while the power supply is plugged in. If you start capturing images while your laptop power supply is not plugged in, a pop-up will appear to remind you about this. See Figure 3-10.

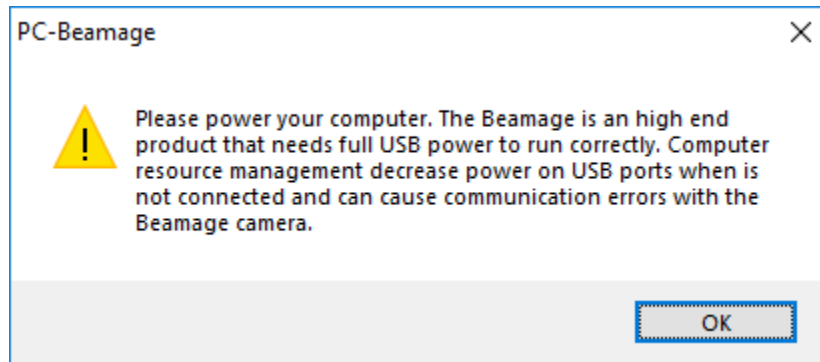

Figure 3-10 Warning about using the software while running on battery



PC-Beamage software prevents the computer from going into sleep mode while the application is active. If your laptop is not plugged in while you are using the software, you may run out of battery power unexpectedly, and lose any unsaved data.

3.3.4. Subtract Background

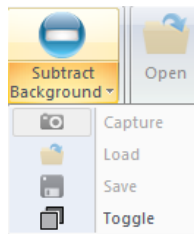

Figure 3-11 Subtract Background button

The “*Subtract Background*” button includes a drop-down menu in its lower part. The list contains a “*Capture*” button, a “*Load*” button, a “*Save*” button and a “*Toggle*” button.

When you start capturing images while the Subtract Background button is not activated, the diameter measurements under “*Measurements*” will appear in red, along with a button that says “*About background subtraction*”. This is to remind the user that the measurements are only valid after first doing a background subtraction. In general, you should never make measurements without doing first a background subtraction.

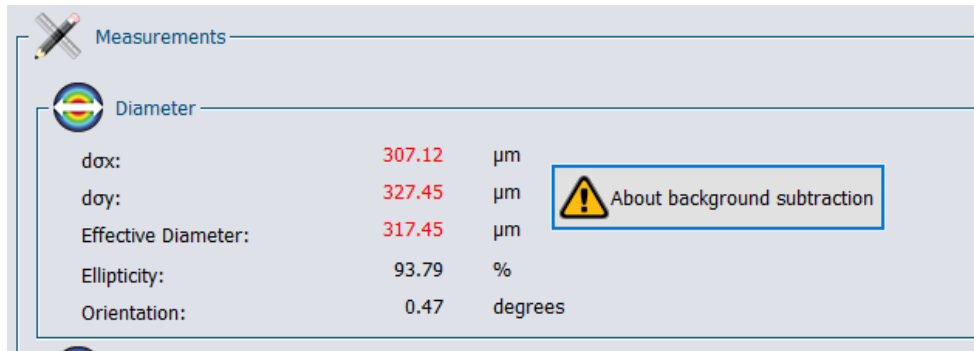

Figure 3-12 “About background subtraction” button

When you click on the button, a message appears, giving steps to follow on how to use Subtract Background, see Figure 3-13

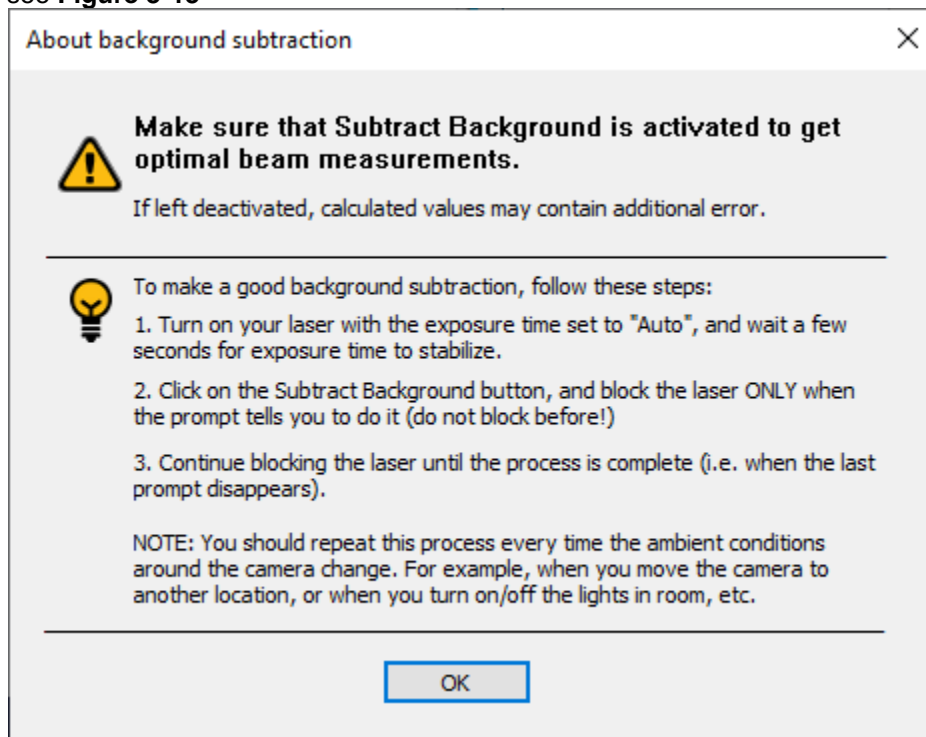

Figure 3-13 “About background subtraction” message



It is mandatory to make a background subtraction to comply with ISO-11146-3:2004 (Section 3).

Once you have clicked the upper part of the “Subtract Background” button or the “Capture” button in the drop-down menu, the following message box will appear:

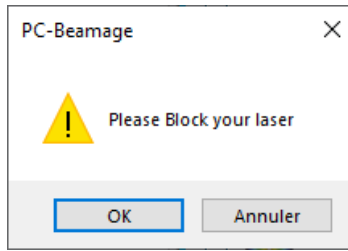

Figure 3-14 "Please block your laser" message

Once this message box appears, block the beam and click on "OK". The software will capture 10 images and average pixel by pixel to compute the *average detector background map*. A "Please Wait" message box will appear while the software is capturing the *background map*.

Once the background subtraction routine is done, the Subtract Background button turns orange. The beam can then be unblocked to begin a measurement.

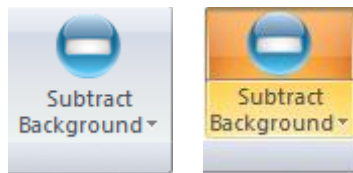

Figure 3-15 : The Subtract Background button becomes orange once the background noise map is captured

The detector background map will be subtracted from all the images that will follow. Note that once the background subtraction has been done, the exposure time will no longer be in "Auto" mode and set to the current exposure time. The diameter measurements will no longer appear in red, and the "About background subtraction" button will disappear.

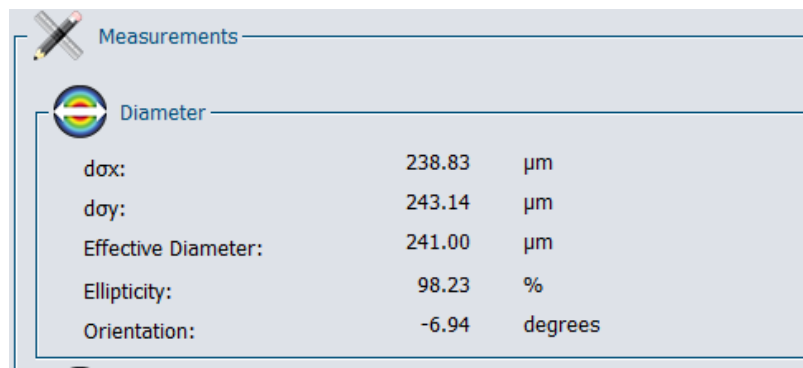

Figure 3-16 Diameter measurements while background subtraction is active

To load a background map (*.BMG file) that already exists on your computer, simply click the "Load" button in the drop-down menu and browse the file on your computer. To save your background map (*.BMG file) on your computer, simply click the "Save" button in the drop-down menu.

It is possible to toggle ON or OFF the background subtraction at any moment by simply clicking the "Toggle" button in the drop-down menu.

It is also possible to see the background. To see it, stop the capture and simply click the "Open File Button" (section 3.6.1). The background has the same format (*.BMG file) as all Beamage images.



Tip

If the *Exposure Time* is set to “Auto”, be sure to block your beam only when the Message Box appears and not before.

3.4. BUFFER CONTROLS

The PC-Beamage software saves the last 128 frames in the buffer. This buffer is circular, the first stored frame is replaced by the last taken image. The buffer can store from 1 to 128 frames. By default, the buffer size is 10.

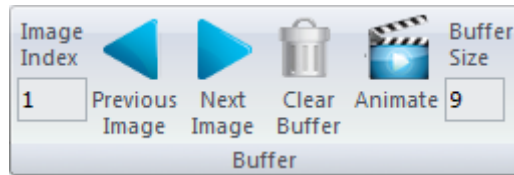

Figure 3-17 Buffer controls



Warning

Note that all images are stored in the RAM memory of your computer, which could limit the number of images in the buffer.

3.4.1. Image Index

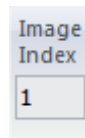

Figure 3-18 Image Index

The “*Image Index*” edit box displays the current image index. When the Beamage is not streaming, it is possible to access different frames by typing the desired image index.

3.4.2. Exposure Time

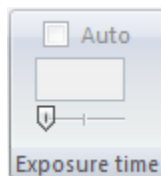

Figure 3-19 Exposure time

The Exposure time can be set to a certain value between 0.06 ms and 200 ms by typing the desired value in the “Exposure time” box. Click the “Auto” checkbox to let the camera set itself to a suitable exposure time. Drag the slider to adjust the exposure time using the mouse cursor; slide to the right to increase the value.

3.4.3.Video Trigger

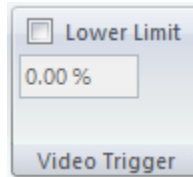

Figure 3- 20 Video Trigger

The Video Trigger function monitors the laser beam saturation peak to decide whether an image must be saved or ignored. This feature is used to record images when the saturation peak exceeds or equals a threshold specified by the user. Images are recorded by the software in such cases, while images are rejected if the saturation peak is lower than the defined threshold.

Using the Video Trigger Function:

1. **Activating the Video Trigger Function:** The Video Trigger function can be activated by checking the "Lower Limit" checkbox in the main control.
2. **Setting the Saturation Threshold:** The user can set the desired saturation threshold percentage (0 at 100%) in the Video Trigger function settings. This threshold corresponds to the level of saturation at which images will be recorded.
3. **Real-time Monitoring:** Once activated, the software continuously monitors the saturation level of the laser beam.
4. **Recording Images:** If the saturation peak of an image exceeds or equals the threshold specified by the user, the software automatically records it. These images are stored for later analysis.
5. **Rejecting Images:** If the saturation peak is lower than the defined threshold, the captured images are not recorded but rather rejected by the software.

Note: It is recommended that the user accurately adjusts the saturation threshold to ensure optimal results when using the Video Trigger function. Adjustments may be necessary depending on lighting conditions and properties of the laser beam being used.



Warning

When the Video Trigger function is active, the Auto Exposure Time function is not available. However, the manual exposure time function remains accessible, allowing the user to manually control the exposure time of the images.

3.4.4. Previous and Next Image



Figure 3-21 Previous Image and Next Image buttons

The “*Next Image*” and “*Previous Image*” buttons access the next and previous image in the buffer.

3.4.5. Clear Buffer

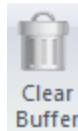

Figure 3-22 Clear Buffer button

The “*Clear Buffer*” button clears the entire buffer. The captured frames will no longer be available, and any measurements will also be erased.

3.4.6. Animate

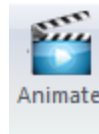

Figure 3-23 Animate button

Once the Beamage has captured frames in its buffer, it is possible to stream them in a playback manner. With as much as 128 frames temporarily saved in the buffer, simply clicking the animation button will create an animation with any display (2D, 3D, and XY). This allows to visualize the beam while working offline and to have a recalculation process if the beam diameter definition or crosshair parameters are changed.

3.4.7. Buffer Size

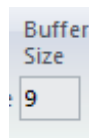

Figure 3-24 Buffer Size

The “*Buffer Size*” edit box displays the number of images stored in the buffer. It is possible to change the buffer size from 1 to 128 images.

3.5. COMPUTATIONS

The “*Computations*” menu contains the “Filters”, “Normalize”, and “Trigger” functions.

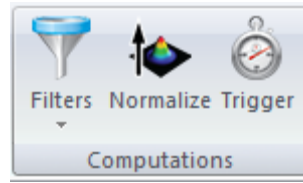

Figure 3-25 Computations

3.5.1.Filters

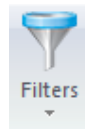

Figure 3-26 Filters button

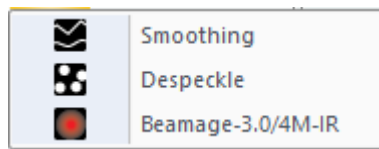

Figure 3-27 Available filters

The “*Filters*” button opens a dropdown menu with 3 options. Two spatial filters are available: “*Smoothing*” and “*Despeckle*”. These two filters are useful for low-quality lasers or low-level signals. Note that the “*Despeckle*” filter is more aggressive than the “*Smoothing*” filter, which makes it ideal for very poor quality beams.

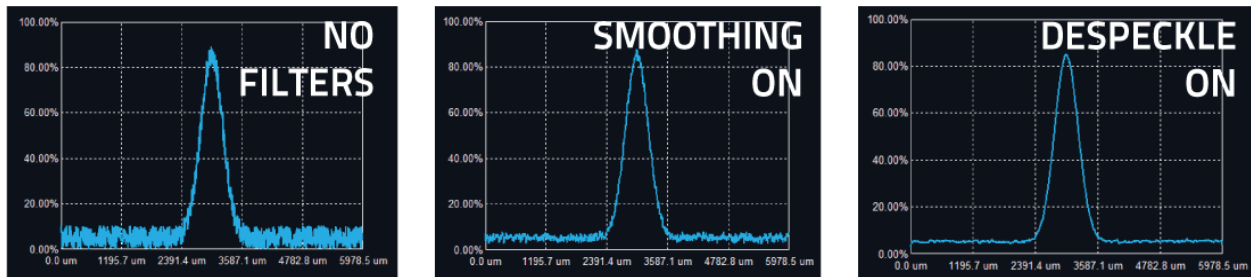

Figure 3-28 Effect of “*Smoothing*” and “*Despeckle*” filters



Warning

If an image is saved while it is in “*Filter*” mode, the resulting filtered image will be saved

Smoothing Filter

The “*Smoothing*” filter performs a 3x3 mask triangular filter. The center pixel has a higher weight (3/11) than the surrounding pixels (1/11). If the filtered pixel is on the edge, it will set the surrounding pixels outside the image to 0.

Despeckle Filter

The “*Despeckle*” filter uses a 9x9 mask flat filter to perform a simple averaging of the central pixel. All pixels have the same weight (1/81). If the filtered image is on the edge, the surrounding pixels outside the image will be set to 0.

IR Sensors Filter

The “*Filters*” button also contains the “*IR Sensors*” correction factor. With a Beamage-4M-IR camera, this filter must be activated. Then, a correction factor is applied to the intensity of each pixel, according to the following correction formula:

$$IR \text{ Pixel Intensity} = A * f(\text{Pixel Intensity})^{\text{Correction Factor}}$$

Note that for the IR camera, the use of a B3-IR-Filter is strongly suggested as it highly enhances the SNR, hence providing a better sensitivity and better profile calculations.

3.5.2. Normalize

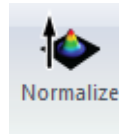

Figure 3-29 Normalize button

The “*Normalize*” button will spread the graph’s (3D, 2D, and XY) intensity over the full range (0% to 100%). Note that only the displays are normalized, the normalization does not affect the centroid and diameter computations.

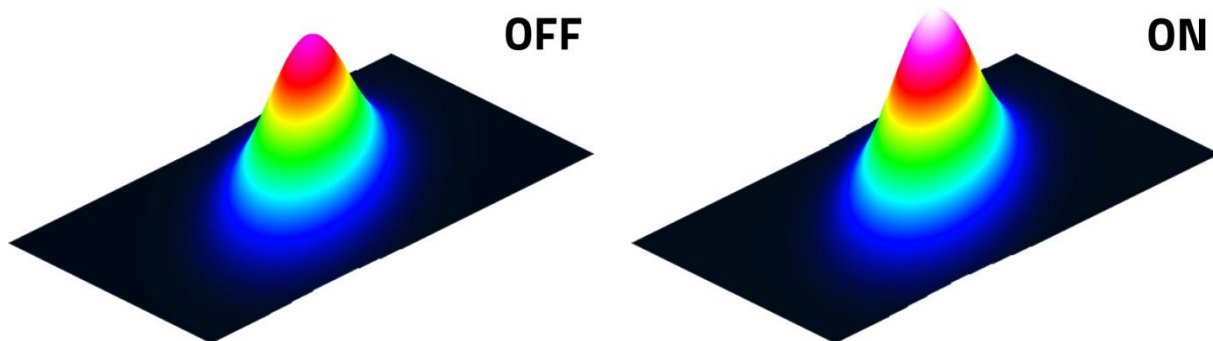

Figure 3-30 Normalization example

3.5.3.Trigger

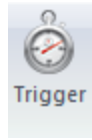

Figure 3-31 Trigger button

The “*Trigger*” button enables the camera to capture images only when an electric signal is sent to the Beamage via the SMA connector. This can synchronize the system’s capture rate with a pulsed laser source. A SMA to BNC adaptor is provided. The input trigger signal can be from 1.1 volts to 24 volts. The rise edge response time is 300 ns. The pulse width of the trigger signal must be between 300 ns and 230 ms.



Figure 3-32 SMA Connector for Trigger Input

3.6. FILE CONTROLS

The “*File Menu*” opens and saves frames captured with the Beamage, and also prints a complete report. These controls are not available while capturing images, except for “*Start Data Acquisition*” function, which is only available while the camera is streaming.

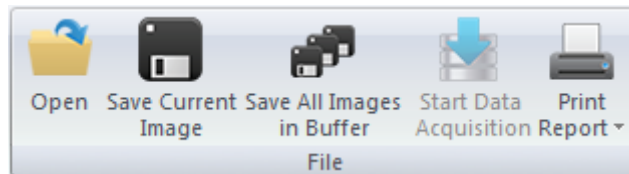

Figure 3-33 File Controls

3.6.1.Open

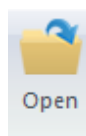

Figure 3-34 Open File Button

Click on the “*Open*” file button to retrieve previously saved data. The PC-Beamage software will only open native *.BMG files. The files can contain between 1 and 128 frames, depending on how the file was created (refer to section 3.6.2 and 3.6.3). If the file was saved with multiple frames, it will be possible to access all of them with the *Buffer Control* (refer to section 3.7), also all settings in “Home” and “Setup” panel will be loaded, as well as the exposure time value, auto exposure time button state, the background button state (information only) the filters button state, the normalize button state and trigger button state.



Tip

The *. BMG file name and camera serial number will appear in the header of the PC-Beamage software, see **Figure 3-35**

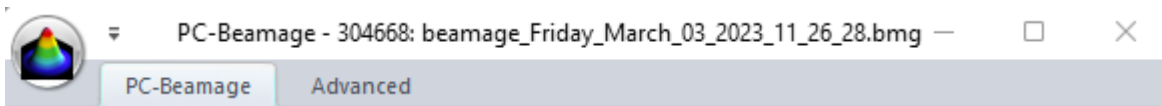

Figure 3-35 Serial Number and File name loaded from BMG file

3.6.2. Save Current Image

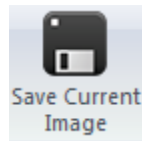

Figure 3-36 Save Current Image Button

Click on the “*Save Current Image*” button to save the currently displayed image. This option will only save 1 frame. Data can be saved in native *.BMG format, in text *.TXT format or in binary *.BIN format. Note that only the *.BMG format can be re-opened with the PC-Beamage software.

The *.TXT and the *.BIN files must be used with a compatible software. The *.TXT file saves a header containing the measurement settings followed by the sensor’s output matrix. Every pixel output is separated by a semicolon. The *.BIN file only saves the data and does not contain a header. The *.BIN file saves data on signed 32 bit integers.

3.6.3. Save All Images in Buffer

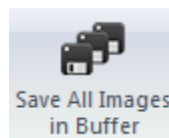

Figure 3-37 Save All Images in Buffer Button

Click on the “*Save All Images in Buffer*” button to save all the frames stored in the buffer. Data can be saved in native *.BMG format, in text *.TXT format or in binary *.BIN format. Note that only the *.BMG format can be re-opened with the PC-Beamage software. When opening the *.BMG file, all the stored images will be accessible via the *Buffer Controls* menu, including all the calculated measurements (refer to section 3.7).

When saving in *.TXT or *.BIN file, a series of files will be saved and identified with their respective buffer index number. The *.TXT and the *.BIN files must be used with a compatible software. The *.TXT file saves a header containing the measurement settings followed by the sensor’s output matrix. Every pixel output is separated by a coma. The *.BIN file only saves the data and does not contain a header. The *.BIN file saves data on signed 32 bit integers.

3.6.4. Start Data Acquisition

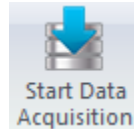

Figure 3-38 Start Data Acquisition Button

Click on the “*Start Data Acquisition*” button to start the data logging of all the measurements displayed in the “*Home*” tab. This function is only available while the camera is streaming. The acquisition parameters can be modified in the “*Data Acquisition*” tab on the right-hand side of the user interface (refer to section 4.3).

It is only possible to save the beam profiling results shown in the “*Home*” tab (refer to section 4.3) in a *.TXT file. The *.TXT file includes a header, containing the acquisition settings, followed by the data. Each line corresponds to a single frame and all the measurements are separated by a tab. This file can be opened in a spreadsheet software, such as Microsoft Excel.

It is also possible to save the images associated with the measurements saved in the *.TXT logging file. Each image will be individually saved in format *.JPG, *.BMP and a native *.BMG file. Each file will have the same filename as the *.TXT file, followed by the corresponding increment.



Warning

Each *.BMG file can take up to 8.50 MB, each *.JPG file can take up to 200KB and each *.BMP file can take up to 1.2 MB on the hard drive. Acquiring multiple frames can quickly sum up to multiple GB of data.

Fast acquisition should only be done on the computer’s hard drive and cannot be done on an external drive or on a server hard drive.

3.6.5. Print Report

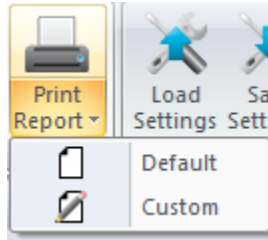

Figure 3-39 Print Report button

Click on the *Print Report* button and choose the *Default* option to print a complete report of the current measurements and measurement settings. To add or remove specific pieces of information from the report, choose the *Custom* option and a dialog box will allow you to select what elements should appear in the report

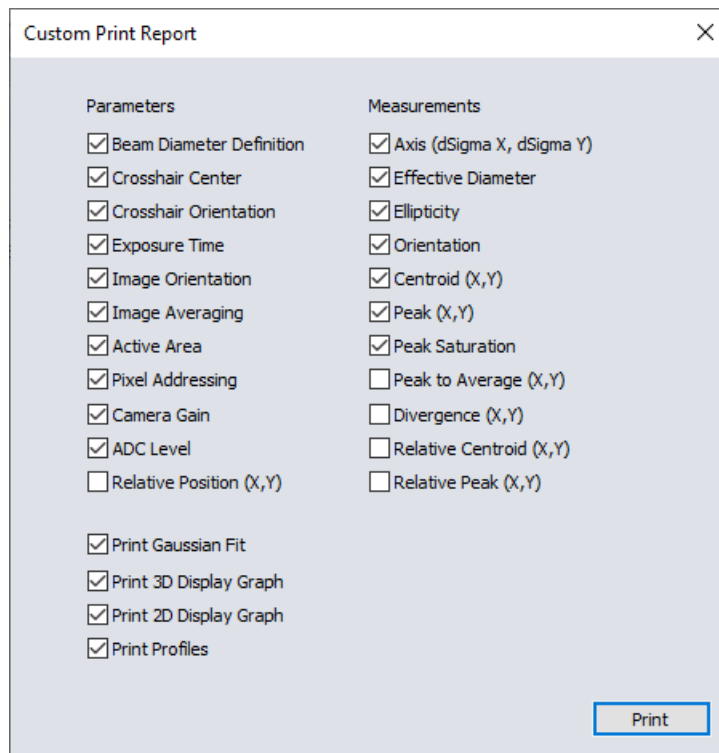

Figure 3-40 Custom Print Report dialog

After choosing the default or the custom report, a print preview will appear in the PC-Beamage software. To print the report, click "Print". To exit without printing, click "Exit". These buttons are located on the right-hand side.

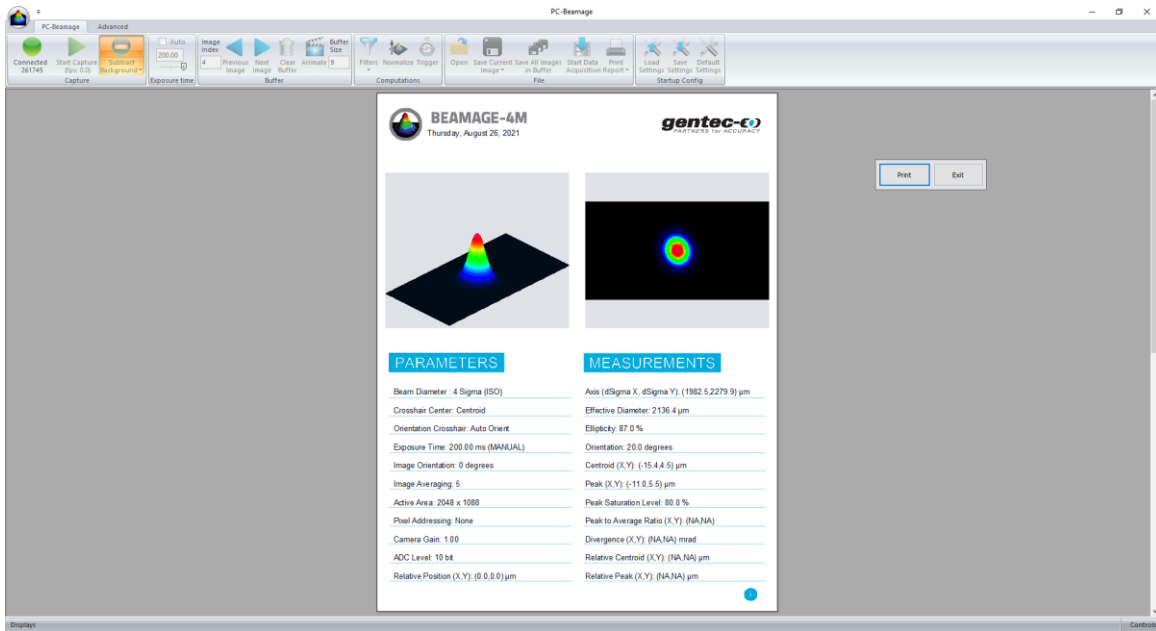

Figure 3-41 Print Report Preview

The report fits on 2 pages. The first page presents the 3D and 2D images, measurements, and the Beamage settings.

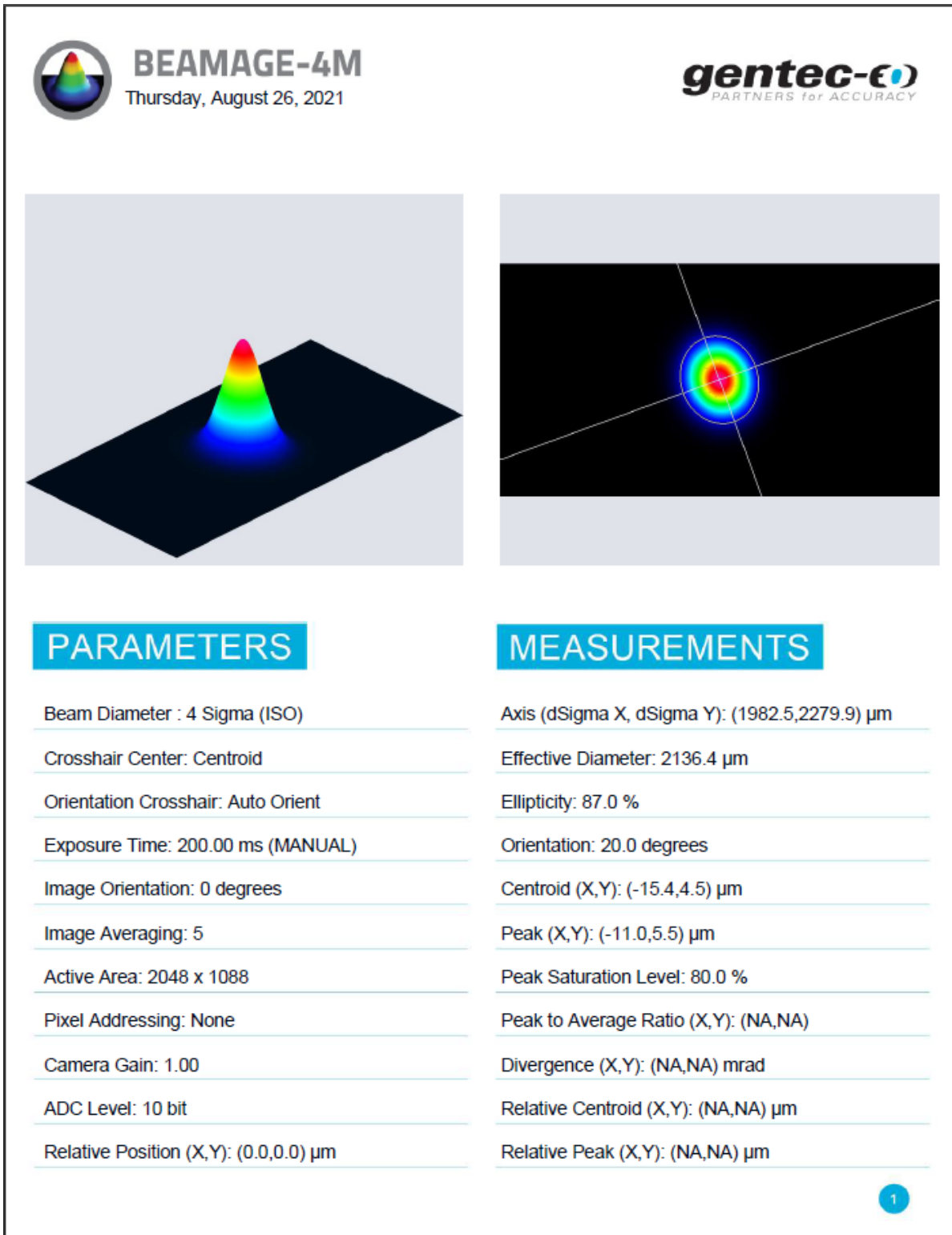

Figure 3-42 Default Print Report Page 1

The second page prints the cross-sectional XY graphs along the crosshairs. If the “Cursor”, the “Gaussian Fit”, “FWHM”, or the “1/e²” options are selected, they will also appear in the report.

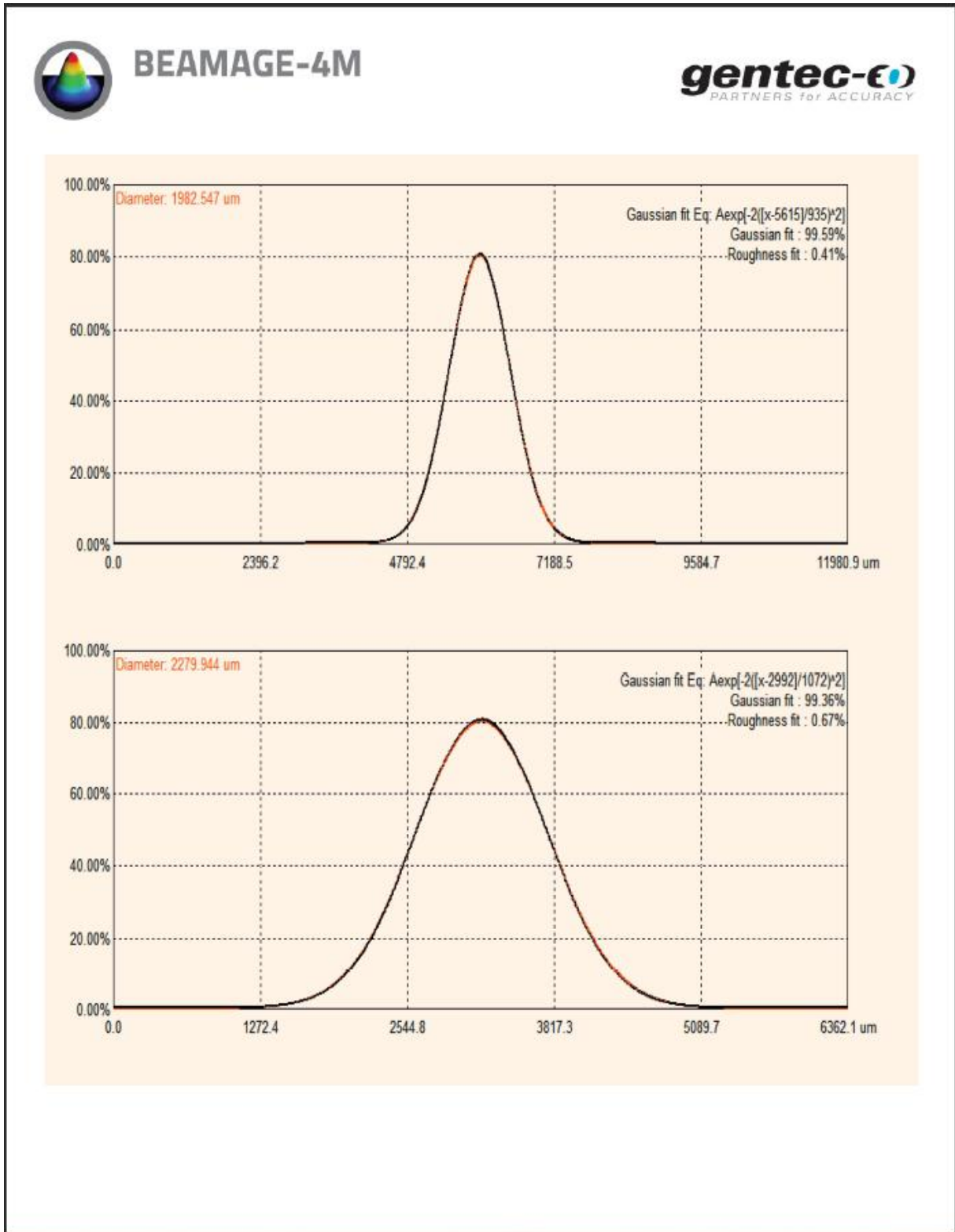

Figure 3-43 Default Print Report Page 2

3.7. STARTUP CONFIG CONTROLS

The PC-Beamage software can load, save and reset to the default factory state the software settings. The file extension is *.geo.

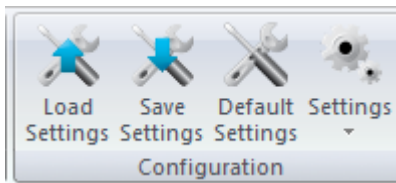

Figure 3-44 Startup Config Controls



Tip

When closing the PC-Beamage, all current settings will be saved and will automatically be loaded the next time PC-Beamage is opened.

The complete list of settings saved can be found in the appendix section.

3.7.1.Settings Buttons

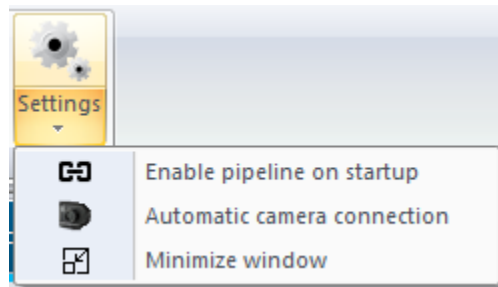

Figure 3- 45 Settings button

The Settings section allows you to customize various aspects of the application's behavior.

Enable Pipeline on Startup: Select this option to enable the pipeline feature automatically upon application startup. When enabled, the application will initiate the pipeline functionality without requiring manual intervention.

Automatic Camera Connection: Select this option to automatically connect to the first available camera upon application launch. This streamlines the process of assessing the camera's functionalities without the need for manual selection.

Minimize Window: Select this option to minimize the application window to the system tray upon startup. This feature helps reduce clutter on the desktop and ensures that the application remains accessible while occupying minimal screen space.



Tip

Selecting all three settings allows you to automate your workflow. These configurations are specific to the software and are not dependent on the connected camera.

3.8. ADVANCED COMPUTATIONS

The PC-Beamage software offers advanced computation features for specific applications. These options can be hidden or shown depending on your needs. These controls can be found in the *Advanced* ribbon tab.



Figure 3-46 Startup Config Controls

3.8.1. Show/Hide Options

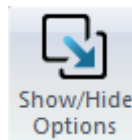

Figure 3-47 Show/Hide Options Button

The “*Show/Hide Options*” button will show or hide the “*Divergence*”, the “*Relative Position*”, “*Camera Lens Calibration*” and “*Fixed Crosshair*” panels beside the “*Data Acquisition*” tab. By clicking on “*Show All*” or “*Hide All*”, one can show or hide both tabs at the same time. The “*Start LabVIEW Pipeline*” button will open the communication channel between the PC-Beamage and the LabVIEW driver. Please refer to section 7 for more information about this function.

3.8.2.Divergence



Figure 3-48 Divergence Button

The “*Divergence*” button activates a new tab on the right-hand side of the user interface. It contains all the settings and results relative to the beam divergence (refer to section 4.4). The measurement is the total angle (full-angle). To compute the divergence and abide by the ISO-11146-1:2005 standard, the first step is to place an aberration-free lens between the Beamage and the laser. The lens should be placed in the far-field of the laser beam while the Beamage should be at the focal point of the lens. The second step is to enter the focal length of the lens in the software. Since the focal length is wavelength dependent, make sure to use the correct value for your laser in the settings. The divergence in both main axes (x and y) are computed as defined by the ISO-11146-1:2005 and ISO-11146-2:2005 standards and displayed at the bottom of the “*Divergence*” tab.



The Beamage sensor must be placed precisely at the focal point, not at the beam waist.

3.8.3.Relative Position

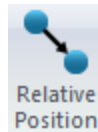

Figure 3-49 Relative Position Panel

The “*Relative Position*” panel activates a new tab on the right-hand side of the user interface. It contains all the settings and results relative to the origin position. This tool allows you to easily align a laser to any desired position. Please refer to section 4.5 for more information about this functionality.

3.8.4.Camera Lens Calibration



Figure 3-50 Camera Lens Calibration Panel

The “*Camera Lens Calibration*” panel activates a new tab on the right-hand side of the user interface. It contains the procedure relative to the camera lens calibration. This tool allows you to easily calibrate a system that contains a magnifying lens. Please refer to section 4.6 for more information about this function.

3.8.5.Fixed Crosshair

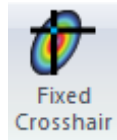

Figure 3-51 Fixed Crosshair Panel

The “Fixed Crosshair Panel” panel activates a new tab on the right-hand side of the user interface. It contains the settings relative to the fixed crosshair. This tool allows you to easily fix and see the crosshair at a precise position on the sensor, and also to adjust the crosshair’s orientation. Please refer to section 4.7 for more information about this function.

3.8.6.Pipeline



Figure 3-52 Third Party Pipeline

The measurements computed by PC-Beamage can be sent to a third party application written in LabVIEW or in any .Net language. To do so, you must activate the pipeline to open the communication between the two software applications. Please refer to section 7 for more information.

3.8.7.2D High Resolution

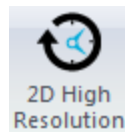

Figure 3-53 2D High Resolution

The PC-Beamage offers the possibility to lower the 2D resolution, only showing 1/16 pixels, offering a higher frame rate. By default, the PC-Beamage is always in 2D high resolution. This feature is especially useful when viewing a large beam and when high speed is a priority.

3.9. BEAMAGE-M2 MODE

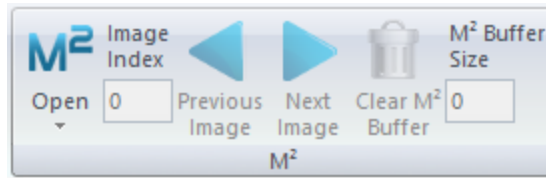

Figure 3-54 Show/Hide M² Mode Tabs

The M2 mode activates the M² measurement functions of PC-Beamage software. The M² factor can be considered as a quantitative indicator of laser beam quality. In terms of propagation, it is an indicator of closeness to an ideal Gaussian beam at the same wavelength. For more information on how to use this mode, please refer to the Beamage-M2 user manual.

3.10. M2 FILE

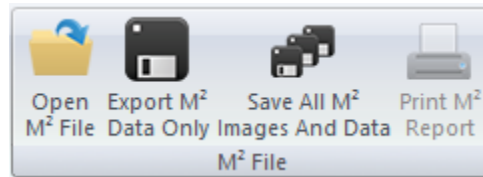

Figure 3-55 M² File

The M2 data and files can be managed via this set of buttons. More info about these can be found in the Beamage-M2 user manual.

3.11. SOFTWARE INFO

The “*Information Menu*” displays important and useful information about the Beamage and provides help.

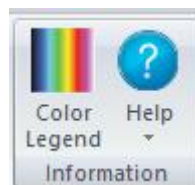

Figure 3-56 Software Info

3.11.1. Color Legend

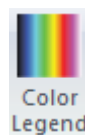

Figure 3-57 Color Legend Button

The “Color Legend” button shows the colors corresponding to the 3D and 2D display intensity levels.



Figure 3-58 Color Legend

3.11.2. Help

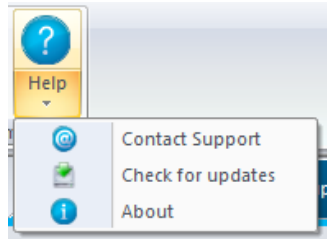

Figure 3-59 Help Button

The *Help* button opens the *Contact Support* panel, it is also possible to check for updates with the *Check for updates* options and you can also click *About* to learn more about the software.

If you need support or help with your PC-Beamage software you can contact a Gentec-EO representative by clicking on the *Contact Support* button. By clicking on this button, a *Contact Support* panel will appear and will prompt you to fill in the required information.

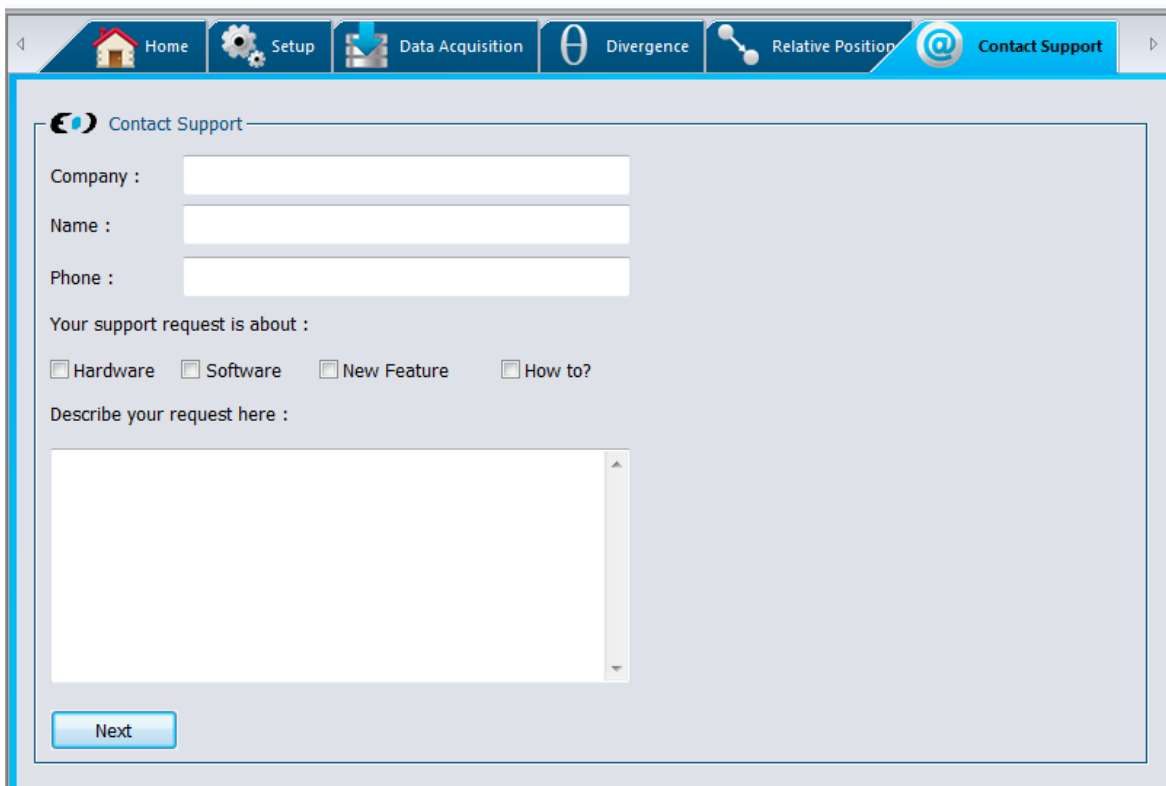

Figure 3-60 Contact Support Panel

Once you click *Next*, an automatically-generated email will appear containing information about your PC-Beamage setup and your beam profiler. You can also attach any files, images, or documents concerning your issue to this email.

To learn more about the PC-Beamage software, camera and sensor, click the *About* Button.



Tip

You can also obtain the latest PC-Beamage software version on our website at www.gentec-eo.com/downloads

4. HOME AND SETUP PANELS

The PC-Beamage offers different panels to view the measurements and set different options for the Beamage.



Home: Controls the computation parameters and displays the beam's diameter and centroid information.



Setup: Controls the Beamage parameters.



Data Acquisition: Controls the acquisition parameters



Divergence: Controls the divergence parameters and displays the results. This tab is available when the *Divergence* button is activated in the *Main Controls* (refer to section 3.8.1).



Relative Position: Sets the origin position (0,0) to a user-defined value. This tab is available when the *Relative Position* button is activated in the *Main Controls* (refer to section 3.8.1).



Camera Lens: Calibrates the *Pixel Multiplication Factor* when using a Camera Lens. This tab is available when the *Camera Lens* button is activated in the *Main Controls* (refer to section 3.8.1).



Fixed Crosshair: Set the crosshair origin position (0,0) and orientation to a user-defined value. This tab is available when the *Fixed Crosshair* button is activated in the *Main Controls* (refer to section 3.8.1).



M²: Enables the M² measurement functions of PC-Beamage. You may refer to the *Beamage-M²* manual for more information on this mode.

To choose the desired display mode, click on the corresponding tab in the panel on the right side of the interface.

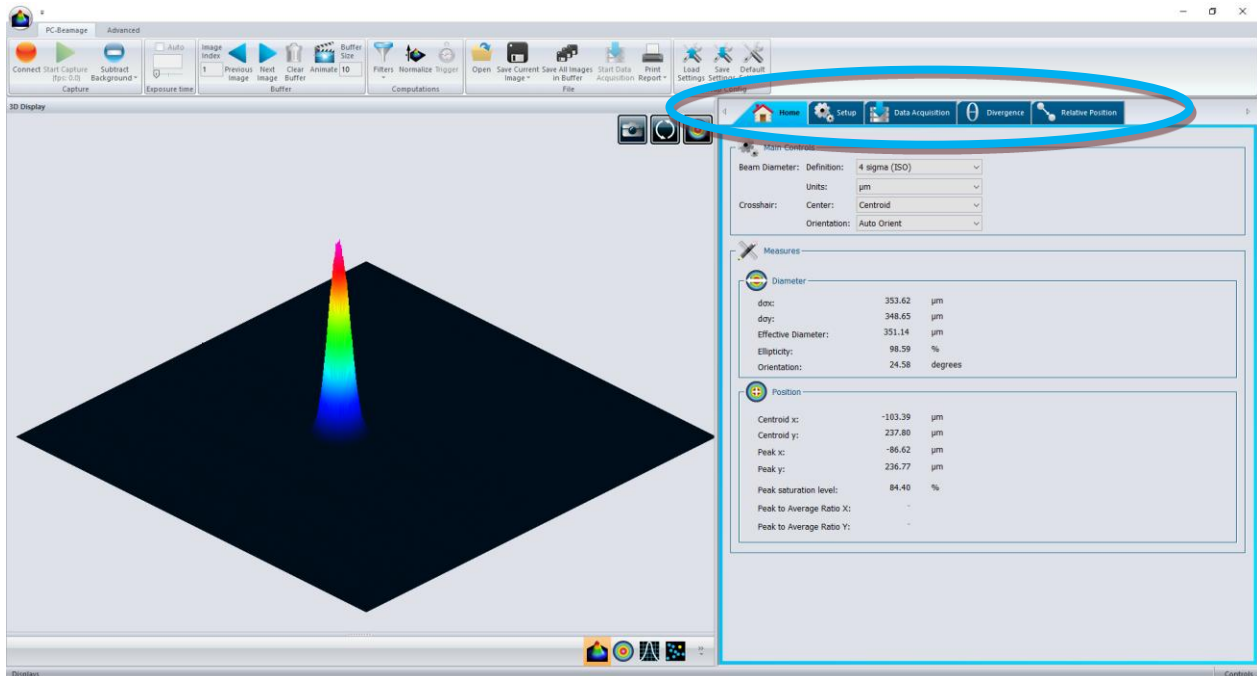

Figure 4-1 PC-Beamage interface

4.1. HOME

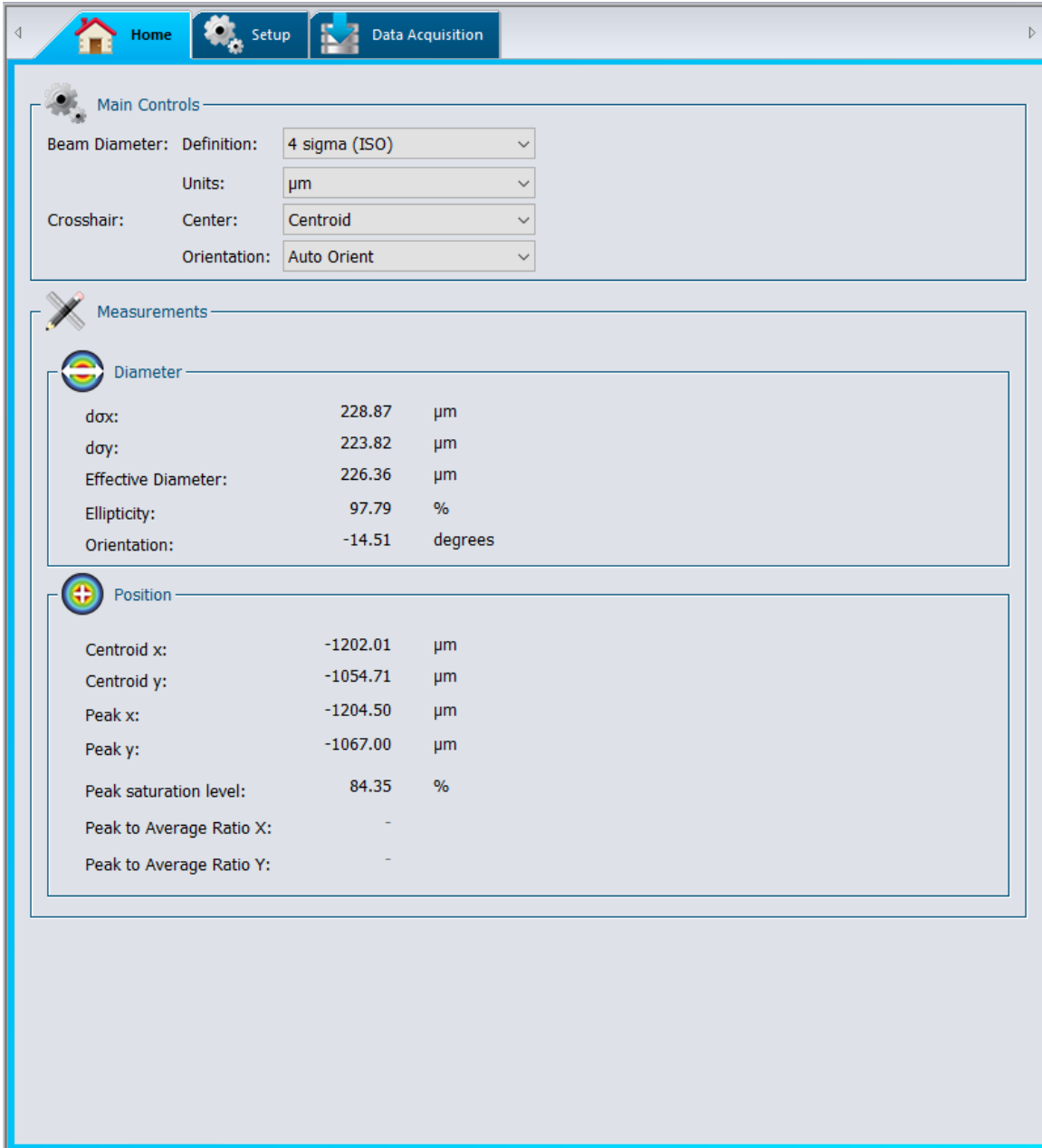

Figure 4-2 Home Tab



Main Controls: Defines the beam width definition and crosshair position.



Diameter: Displays the beam diameter computation results.



Centroid: Displays the beam's centroid and peak coordinates.

4.1.1. Main Controls

The “*Main Controls*” section allows the user to set the desired beam diameter definition and crosshair position. Use the drop-down menu to select the desired settings.

4.1.1.1. Beam Diameter Definition

By default, the beam width definition is set to “*4 sigma (ISO)*” which respects the ISO-11146-1:2005 and ISO11146-2:2005 standards (refer to Appendix A. ISO11146 and ISO11670 definitions). This definition takes the entire image to compute the beam parameters, which slows the computation time and reduces the frame rate.

The “*FWHM along crosshairs (50%)*” finds the crosshair’s Full Width Half Maximum (FWHM). The algorithm will return the width corresponding to the curve’s first half maximum and the curve’s last half maximum. Because the beam definition only takes into account a slice of the beam, the computation time is much faster and higher frame rates can be achieved.

The “*1/e² along crosshairs (13.5%)*” finds the crosshair’s width corresponding to $1/e^2$ (about 13.5%) of its maximum. As with the FWHM, this beam definition will increase the frame rate.

The “*86% effective diameter (D86)*” computes the circular beam containing 86% of the total intensity. This definition assumes the beam is circular.

4.1.1.2. Crosshair Definition

The crosshair is defined by its center (intersection of the 2 crosshairs) and its orientation. The crosshair center can be set to the beam’s centroid as defined by the ISO-11146-1:2005 and ISO-11146-2:2005 standards, the beam’s peak position or at a user-defined fixed position. If many pixels correspond to the peak value, the crosshair’s center will be set to the first peak.

The crosshair’s orientation is set to “*Auto Orient*” by default, which aligns it to the beam’s orientation as defined by the ISO-11146-1:2005 and ISO-11146-2:2005 standards. It can also be set to a fixed 45° or 0° angle, or at a user-defined fixed angle.



Warning

The crosshair definition will affect the Crosshair Display and the beam width if it is defined by the FWHM or $1/e^2$ along crosshair

4.1.2. Measurements

The “*Measurements*” section presents the beam’s diameter and centroid information according to the selected beam definition (refer to section 4.1.1.1).

The computation algorithm first determines an approximate beam diameter (13.5% clip level). The algorithm will consider that all pixels outside 2 times the approximate beam diameter are the *outside area*. The *outside area*’s average will become the *baseline*, which will be subtracted from the *area containing the beam*. Only the *area containing the beam* will be used to compute the diameter. This means that a smaller beam will have a smaller area which will decrease the computation time and increase the frame rate. If the beam is larger and all pixels contain the *area containing the beam*, there will be no *baseline* subtraction and the frame rate will be slower.

4.1.2.1. Diameter

The beam diameter “d_{ox}” and “d_{oy}” refers to the beam width closest to the x horizontal axis and y vertical axis as defined by the ISO-11146-1:2005 and ISO11146-2:2005 standards. If the Beam Diameter Definition is set to “FWHM along crosshair” or “1/e² along crosshair” and the crosshair orientation is set to 0° angle, “d_{ox}” and “d_{oy}” will refer to x as the horizontal axis and y the vertical axis.

The “Effective Diameter” is the beam’s diameter considering it is circular.

The effective diameter is only valid if the ellipticity is greater than 87%. If the beam’s ellipticity is lower than 95%, the effective diameter will be grayed-out, indicating it is not valid.

The “Ellipticity” is the ratio between the minor axis and the major axis. For a perfect round Gaussian beam, the ellipticity would be equal to 100%.

The “Orientation” is defined as the “angle between the x-axis [...] and that of the principal axis of the power density distribution which is closer to the x-axis.”¹ From this definition, the angle is comprised between -45° and 45°.

For more information on beam diameter computations as defined by the ISO-11146-1:2005 and ISO-11146-2:2005 standards, please refer to Appendix A. ISO11146 and ISO11670 definitions)



Warning

According to the beam definition, the displayed measurements will vary. For example, for “86% effective diameter (D86)”, only the effective diameter will be displayed, as the “d_{ox}” and “d_{oy}” diameters, and orientation are not relevant in a perfectly circular beam.

4.1.2.2. Centroid

All positions are relative to the image center which is (0,0). The horizontal axis increases toward the right-hand side and the vertical axis increases toward the top.

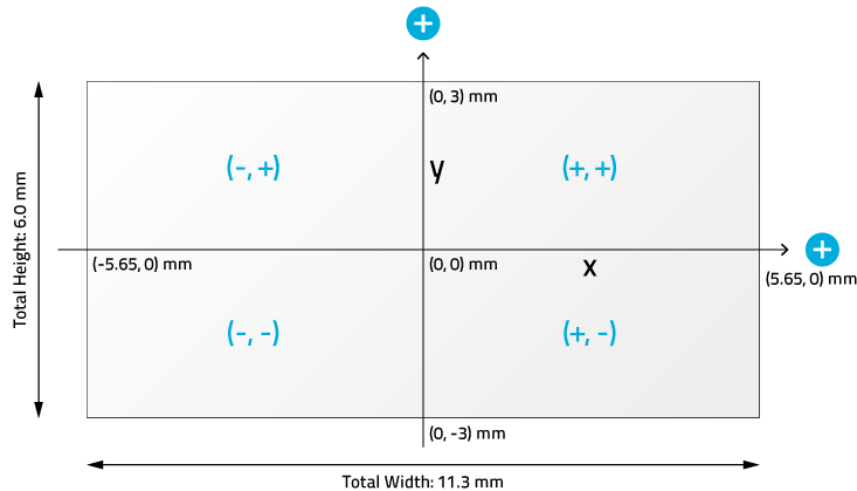

Figure 4-3 Fixed Coordinates System for the Sensor

¹ International Organization for Standardization, *ISO 11146 :2005 Laser and laser-related equipment – Test methods for laser beam widths, divergence angles and beam propagation ratios*, 2005, Geneva

The beam *“Centroid”* corresponds to the beam’s first order distribution as defined by the ISO-11146-1:2005 and ISO-11146-2:2005 standards (refer to Appendix A)

The beam’s *“Peak”* position corresponds to the pixel’s peak value position. If many pixels correspond to the peak value, the crosshair will be centered on the first peak.

The beam *“Peak to Average Ratio”* corresponds to the ratio between the actual beam peak value and the height of an equivalent simulated flat-top beam. The simulated beam’s width is the $1/e^2$ diameter of the actual beam and has the same area (same energy). The software computes the ratios for both the X and Y axes.

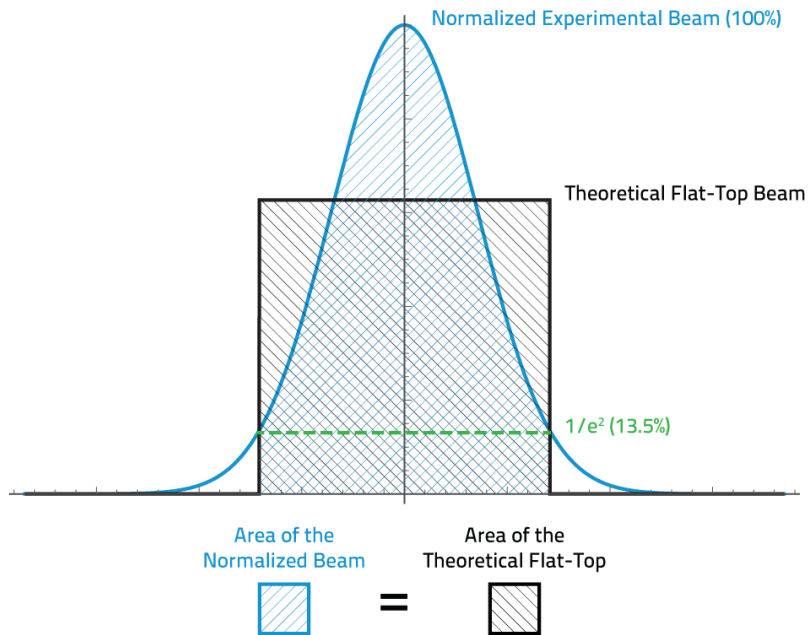

Figure 4-4 Peak to Average

These results are only available when the *“1/e2 along crosshairs (13.5%)”* beam diameter definition is selected. If any other definition is used, the *“Peak to Average Ratios”* are not computed and dashes are displayed. When the crosshair center is set to *“Centroid”* instead of *“Peak”*, results are grayed out to remind the user that the values do not correspond to the *“Peak to Average Ratios”*.

Position		
Centroid x:	-5.50	µm
Centroid y:	-5.50	µm
Peak x:	0.00	µm
Peak y:	-5.50	µm
Peak saturation level:	79.96	%
Peak to Average Ratio X:	1.67	
Peak to Average Ratio Y:	1.67	

Figure 4-5 Peak to Average Ratio Example

4.2. SETUP

The “Setup” tab allows the user to set the Beamage parameters.



Figure 4-6 Setup Tab



Exposure time: Controls the Beamage sensor’s exposure time.



Image orientation: Rotates or flips the captured image.



Image Averaging: Applies a temporal filter by averaging multiple frames



Active Area: Selects the region of interest.



Pixel Addressing: Reduces the spatial resolution by averaging or decimating pixels.



Gain: Adds numerical gain to captured image.



ADC Level: Selects the BEAMAGE’s ADC level for each pixel



Pixel Multiplication Factor: Adjusts the pixel multiplication factor when using optical components

4.2.1. Exposure Time

The “*Exposure Time*” controls the Beamage’s exposure time settings. It can be set from 0.06 ms to 200 ms. The “*Auto*” option will automatically set the exposure time in order to have the maximum beam intensity at 85% of the sensor’s saturation level. The exposure time can also be set manually by clicking on the corresponding radio button and changing the value in ms.



Tip

If the beam is still saturated at a 0.06 ms exposure time, please increase the attenuation in front of the Beamage. If the beam intensity is too low at 200 ms exposure time, please lower the attenuation in front of the Beamage.

4.2.2. Image Orientation

The “*Image Orientation*” controls rotate or flip the captured frame. The captured frame can be rotated to 90°, 180°, or 270°. All angles rotate clockwise. The captured frame can also be flipped horizontally or vertically. If a frame is saved with a rotation and/or a flip, it will keep these orientation settings. Note that the reference axis for the centroid is neither flipped nor rotated. All positions are always relative to the image’s center which is (0,0) and the horizontal axis always increases towards the right-hand side and the vertical axis always increases towards the top.



Warning

When the Beamage is not capturing images and is in “*Animate*” mode or buffer viewing mode, it will neither flip nor rotate the current image, as it has already been captured.

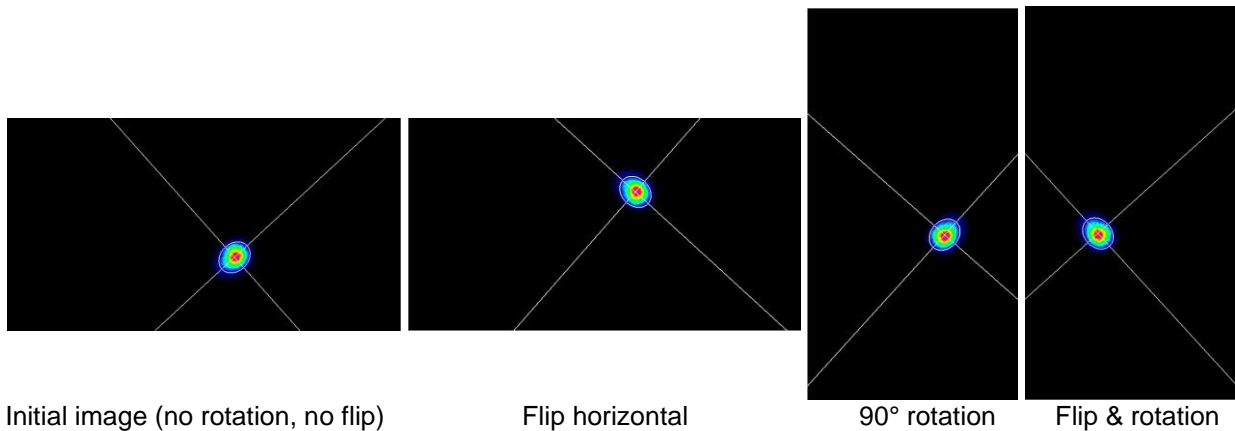

Figure 4-7 Image Orientation Examples

4.2.3. Image Averaging

The “*Image Averaging*” function is a temporal filter that captures a specified number of frames (2, 5, or 10) and averages the frames pixel by pixel to create a single time-averaged image. This lowers the total frame rate because multiple frames need to be captured for one computation.



Tip

Image Averaging will smooth the beam fluctuations that can occur over time. It is very useful when working with unstable laser sources.

4.2.4. Active Area

The “*Active Area*” function allows the user to select a region of interest (ROI) on the sensor. This will increase the frame rate, as fewer pixels need to be transferred from the Beamage. This can only be done on small beam sizes, since a cropped beam would invalidate the beam width measurements. Furthermore, to have an accurate measurement, the active area must be at least 2 times the beam size.

The user can select the desired area from a preset selection or enter a custom size. By default, the area will be placed at the sensor’s upper left corner pixel (0, 0). This position can be changed by entering the active area’s upper left position. Checking the “*Center*” check box will center the active area to the sensor’s center.



Tip

When working with small beams, optimize the speed of the data transfer and still maintain accurate results, by using an *Active Area* that is twice the size of your beam.

4.2.5. Pixel Addressing

The “*Pixel Addressing*” mode allows the user to downsample the captured image. The “*Average 2x2*” will take a 2x2 pixel cluster and return its average as one larger pixel. The “*Average 2x2*” function is only available in the 12-bit ADC mode. The “*Decimate 2x2*” will only return 1 out of the 4 pixels. Because the pixel area is doubled with this mode, it can be used with large beams, where the spatial resolution is not crucial. It will increase the frame rate because fewer pixels are transferred from the Beamage.

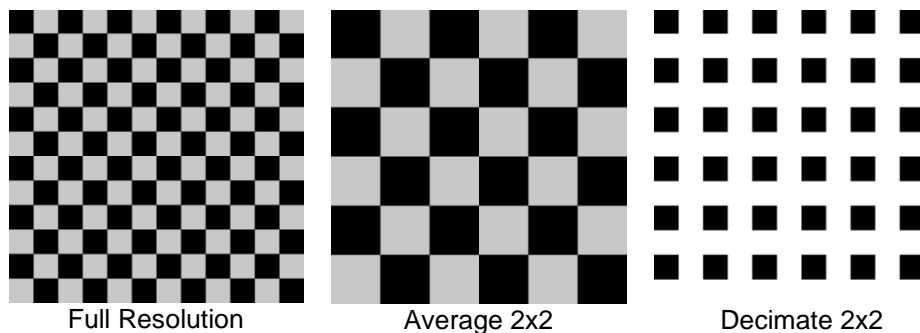

Figure 4-8 Pixel Addressing Mode



Tip

When working with large beams, optimize the speed of the data transfer by reducing the spatial resolution using the *Pixel Addressing* function.

4.2.6. Gain

The “Gain” setting allows the user to set a numerical gain on the captured image. The gain must be between 1 and 10. If the pixel value is over the maximum ADC level (For 12-bit → $2^{12} = 4096$), the pixel value will be topped at the maximum ADC level.

4.2.7. ADC Level

The ADC level is the pixel’s depth which can be set to 12 or 10 bit. In the 12-bit mode, each pixel value is on $2^{12} = 4096$ levels while the 10-bit mode is on $2^{10} = 1024$ levels. The 12-bit mode has a slower frame rate.



Warning

If the Beamage is set in 12-bit mode, it will slow the frame rate.

4.2.8. Pixel Multiplication Factor (PMF)

If the Beamage camera is operated with an optical component that has magnification properties (such as a magnifying lens, a UV Converter or an IR Adaptor), the Pixel Multiplication Factor must be adjusted in order to have the exact beam dimensions. The “*Pixel Multiplication Factor*” section can be found at the bottom of the “*Setup*” tab.



Tip

The default value for the *Pixel Multiplication Factor* is 1.

To obtain accurate value with a **Beamage-4M-FOCUS**, you must enter the *PMF* that is written on the instrument’s certificate.

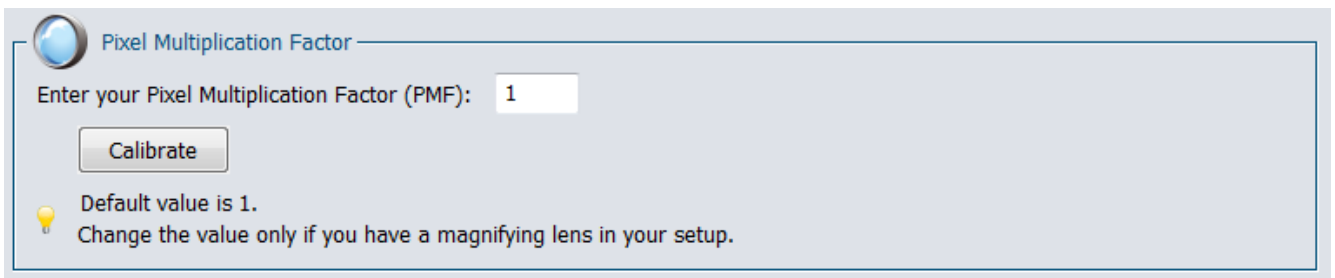

Figure 4-9 Pixel Multiplication Factor

It is possible to manually set a value for the PMF. Simply enter the desired value in the white box and press enter. The beam dimensions will be adjusted accordingly. If a camera lens is used with the Beamage camera, it is possible to follow the camera lens calibration steps by clicking on the “Calibrate” button. This will open the “Camera Lens” tab. Refer to section 4.6 for more information about the camera lens calibration

4.3. DATA ACQUISITION

The “Data Acquisition” tab allows the user to set the acquisition parameters. It is possible to save the beam profiling results shown in the “Measurements” tab (refer to section 4.1.2) in a *TXT file. The *TXT file includes a header, containing the acquisition settings, followed by the data. Each line corresponds to a single frame and all the measurements are separated by a tab. This file can be opened in a spreadsheet software, such as Microsoft Excel. It is also possible to save the images associated with the measurements saved in the *.TXT logging file. Each image will be individually saved in format *.JPG, *.BMP or a native *.BMG file.

Camera Name: PC-Beamage-3.0													
Serial Number: 208111													
Firmware: 1.7													
Description: PC-Beamage-3.0													
Sample Rate: 1 / 1 pulse(s)													
Total Duration: 0:00:15 (DD:HH:MM:SS)													
Date	Elapsed time(sec)	Major Axis(um)	Minor Axis(um)	Effective Diameter(um)	Ellipticity(%)	Orientation(degrees)	Centroid X(um)	Centroid Y(um)	Peak X(um)	Peak Y(um)	Peak Saturation	Peak to Average Ratio X	Peak to Average Ratio Y
09:43:39, Thursday, June 13, 2013	0.421	2666.7	1281.5	2092.1	48.1	29.5	-141.2	977.1	-159.5	858	93.9	2.8	2.4
09:43:39, Thursday, June 13, 2013	0.874	2666.6	1281.5	2092	48.1	29.5	-141.9	977.1	-462	880	89.7	2.8	2.4
09:43:40, Thursday, June 13, 2013	1.466	2667	1282.6	2092.6	48.1	29.5	-141.2	978	-462	880	90.5	2.8	2.4
09:43:40, Thursday, June 13, 2013	1.919	2666.4	1282.2	2092.1	48.1	29.5	-141.8	976.9	-170.5	858	92.4	2.8	2.4
09:43:41, Thursday, June 13, 2013	2.371	2666.1	1281.2	2091.6	48.1	29.5	-141.3	976.1	-456.5	860	95.1	2.8	2.4
09:43:41, Thursday, June 13, 2013	2.808	2669.3	1285.3	2094.9	48.2	29.6	-140.2	978.9	-198	858	93	2.8	2.4
09:43:42, Thursday, June 13, 2013	3.26	2668.2	1284.6	2094	48.1	29.4	-140.6	977.7	-462	880	95.8	2.8	2.4
09:43:42, Thursday, June 13, 2013	3.713	2667.3	1282.5	2092.8	48.1	29.4	-141.8	976.7	-165	858	91.3	2.8	2.4
09:43:43, Thursday, June 13, 2013	4.165	2667.6	1283.3	2093.2	48.1	29.4	-141.9	976.9	-198	858	91.7	2.8	2.4
09:43:43, Thursday, June 13, 2013	4.618	2668	1283.8	2093.6	48.1	29.5	-141.3	977.1	-170.5	869	93.4	2.8	2.4
09:43:44, Thursday, June 13, 2013	5.07	2669.2	1287.1	2095.4	48.2	29.4	-141.1	977.5	-170.5	858	92.5	2.8	2.4
09:43:44, Thursday, June 13, 2013	5.522	2667.7	1283.3	2093.3	48.1	29.4	-141.4	976.7	-170.5	858	94.3	2.8	2.4
09:43:45, Thursday, June 13, 2013	5.975	2668.7	1285.5	2094.5	48.2	29.5	-141.6	977.3	-159.5	869	92.9	2.8	2.4
09:43:45, Thursday, June 13, 2013	6.443	2670	1286.4	2095.6	48.2	29.4	-140.6	978	-462	880	92.7	2.8	2.4

Figure 4-10 Example of an acquisition file generated by PC-Beamage

To start the acquisition, click on the “Start Data Acquisition” button in the “Main Controls” (refer to section 3.6.4).



Tip

When the Video Trigger feature (refer to section 3.4.3) is active, only beams with a saturation peak equal to or greater than the specified value will be recorded in the document. This ensures that only relevant data is saved during acquisition.

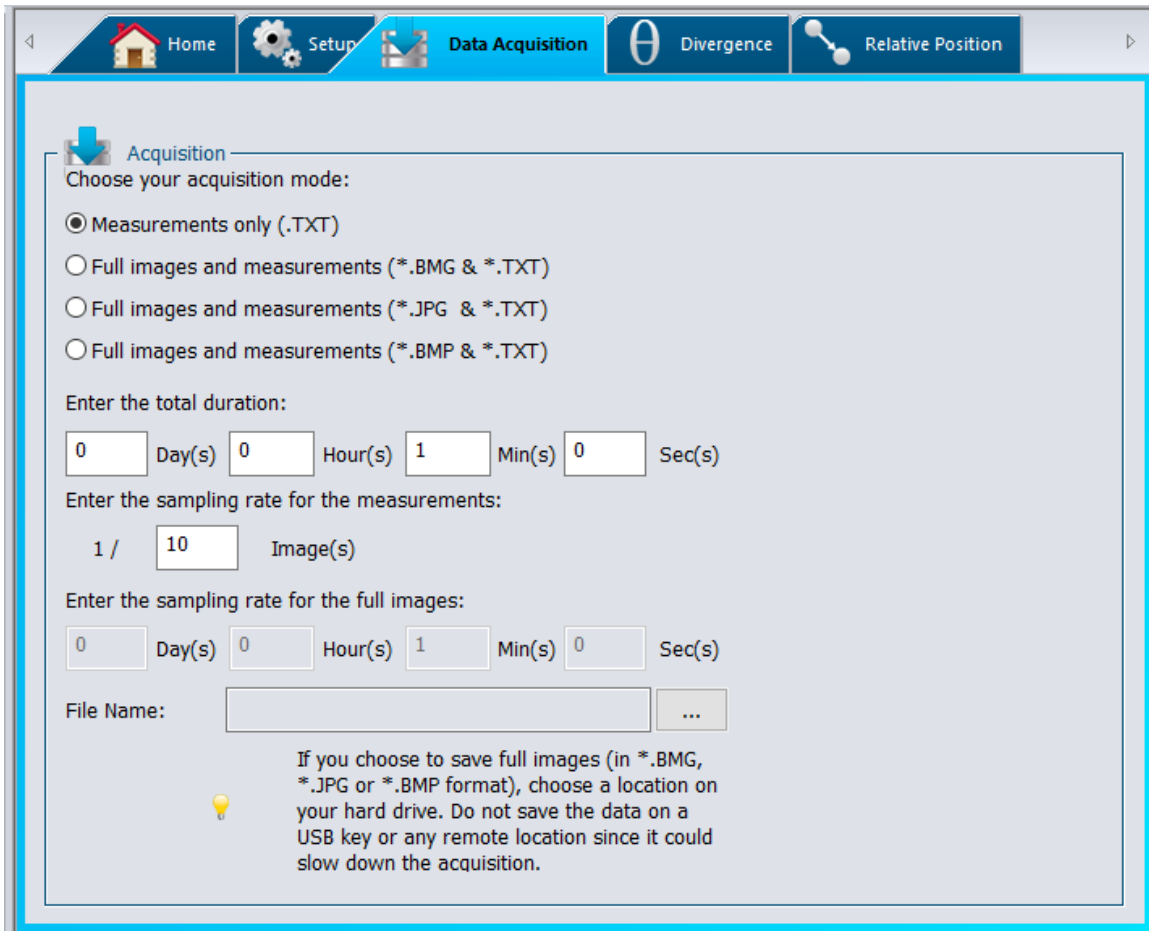

Figure 4-11 Data Acquisition Tab

The “*Duration*” defines the time for which the acquisition will keep running. The countdown starts as soon as the user presses the “*Start Data Acquisition*” button located in the “*Main Controls*”. The user can select the number of days, hours, minutes and seconds.

The “*File Name*” allows the user to specify a name and a path for his file. A filename must be defined to start an acquisition. If the “*Full images and measurements (*.BMG & *.TXT)*” is selected, then a series of “.BMG” files with the same filename concatenated with its corresponding increment will be saved (is the same process for “*Full images and measurements (*.JPG & *.TXT)*” and “*Full images and measurements (*.BMP & *.TXT)*”).

The “*Sample Rate*” defines the rate at which the samples are saved. When choosing the “*Measurements only*” acquisition mode, the sample rate is defined as 1/X images. To save every frame computed, enter the value “1” in the box. To keep track of only a small amount of frames, enter a higher value. When choosing the “*Full images and measurements*” acquisition mode, the sample rate is defined temporally. The fastest rate is limited to 1 per second.



Warning

Each *.BMG file can take up to 8.50 MB, each *.JPG file can take up to 200 KB and each *.BMP file can take up to 1.20 MB on the hard drive. Acquiring multiple frames can quickly sum up to multiple gigabytes (GB). If the total acquisition is over 1 GB, a warning message will appear. If there is only 10 GB left on the hard drive, a warning message will appear and the acquisition will be stopped.

Fast acquisition should be done on the computer’s hard drive and cannot be done on an external drive or on a server hard drive since it could slow down the acquisition.

4.4. DIVERGENCE

The divergence tab opens when the divergence button is clicked in the Main Controls (refer to section 3.8.1). The measurement is the total angle (full-angle).

To compute the divergence and abide by the ISO-11146-1:2005 standard, the first step is to place an aberration-free lens between the Beamage and the laser. The lens should be placed in the far-field of the laser beam while the Beamage is at the lens’ focal point. The second step is to enter the lens’ focal length in the software. Since the focal length is wavelength dependent, make sure to use the correct value for your laser in the prior settings. The divergence in both main axes (x and y) are computed as defined by the ISO-11146-1:2005 and ISO-11146-2:2005 standards and displayed at the bottom of the “*Divergence*” tab (refer to Appendix A).

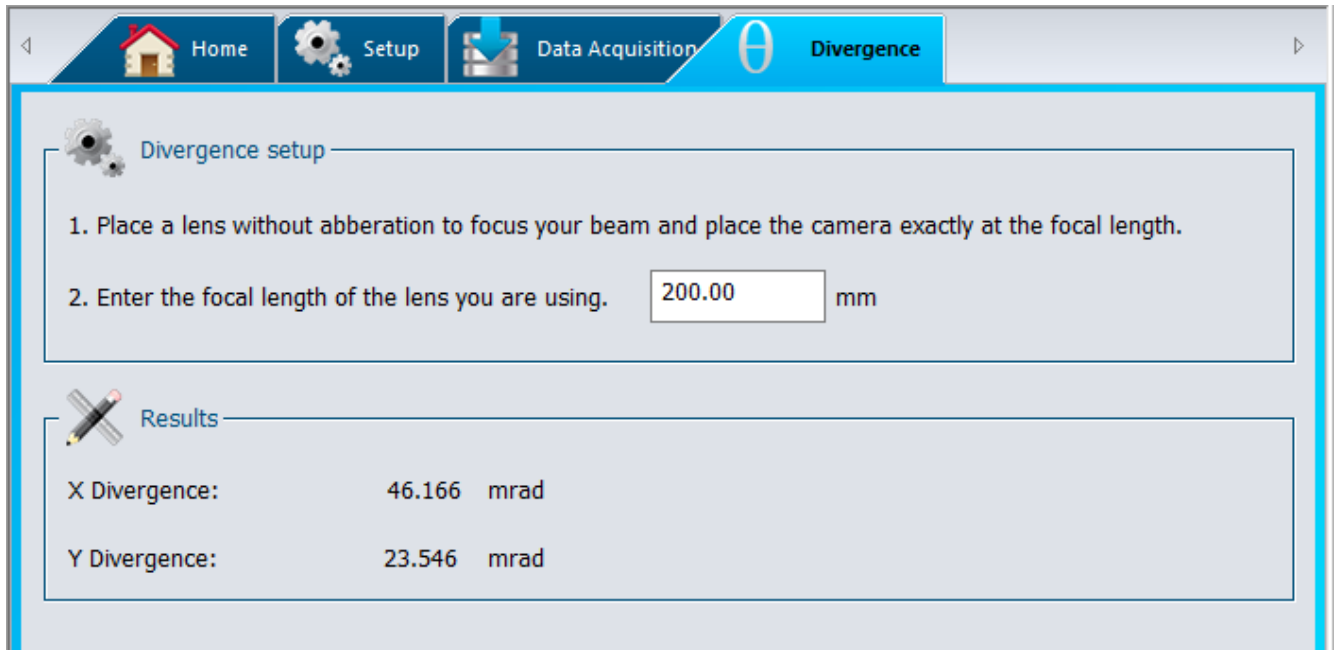

Figure 4-12 Divergence Tab



Warning

The Beamage sensor must be placed precisely at the focal point, not at the beam waist.

4.5. RELATIVE POSITION

4.5.1. Setup

The “Setup” section, which displays the coordinate system of the Beamage sensor on the right side, allows the user to select the parameter that will be considered as the origin position (0,0) by the software.

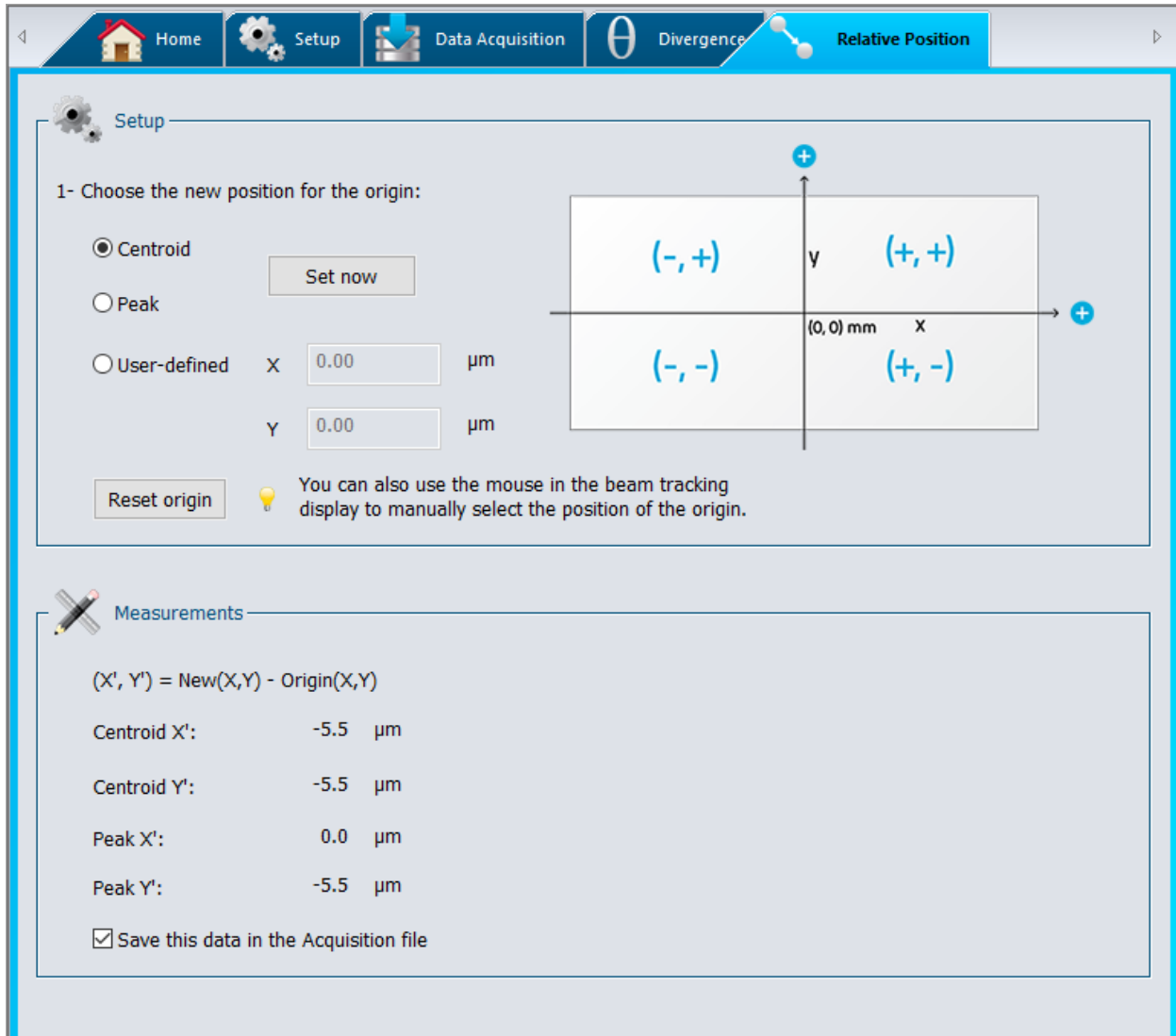



Figure 4-13 Relative Position Tab

By selecting “Centroid” and clicking “Set now”, the user chooses to position the origin at the computed centroid (center of energy). By selecting “Peak” and clicking “Set now”, the user chooses to position the origin at the computed energy peak (highest measured value). The option “User-defined”, allows the user to manually enter origin position values for both the X and Y axes.

It is also possible to position the origin by simply clicking with the mouse in the display. This can be done in the Beam Tracking Display, which shows the coordinate system of the Beamage sensor (refer to section 6.4). First, click on the “Beam Tracking Display” button at the bottom of the display screen to open the

Beam Tracking window. Then, activate the pointer button at the top of the display , and click where you want to position the new origin of the coordinate system. Once you have clicked on the desired point, the

coordinate values for both X and Y axes will automatically be set beside “User-defined” in the “Relative Position” tab.

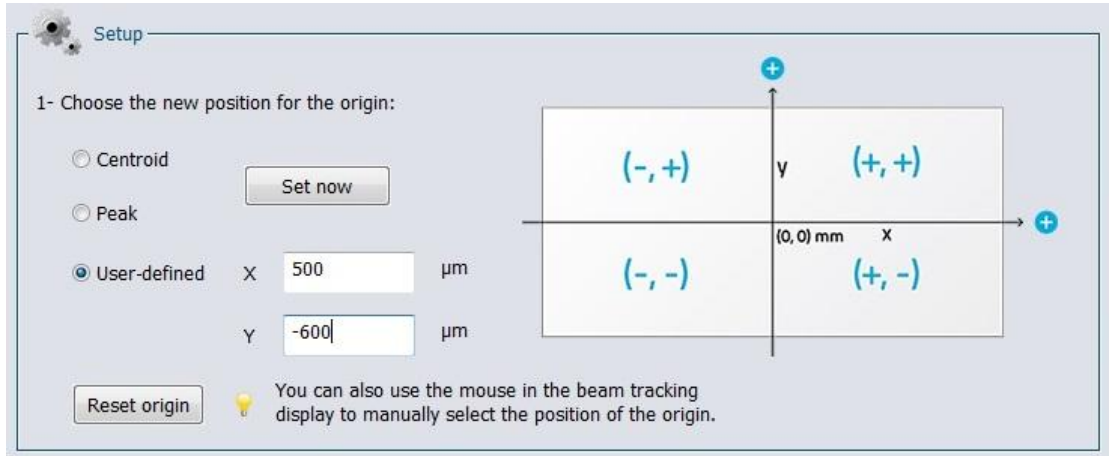

Figure 4-14 Coordinates Defined by User

To set the origin back to its default position (0,0), click on the “Reset origin” button below “User-defined”. This will also automatically select the default option “Centroid” for the origin position.

4.5.2. Measurements

Once the origin position is determined by the user, the software will calculate the difference between the coordinates of this new position and the latest computed centroid or peak coordinates. The results are displayed in the “Measurements” section of the “Relative Position” tab.

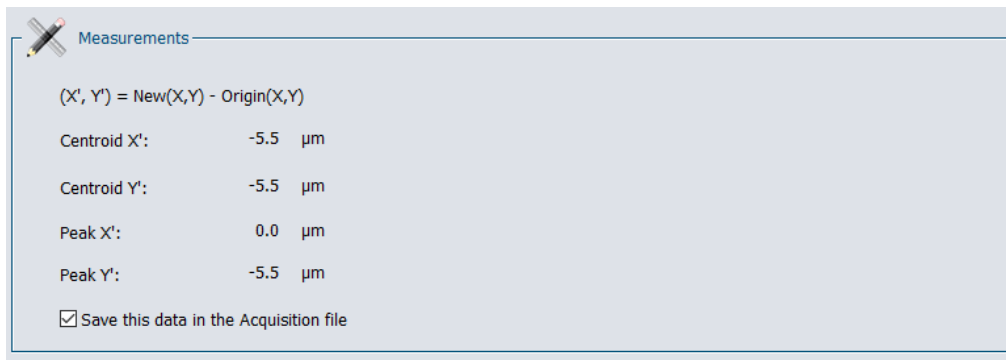

Figure 4-15 Measurements Section

It is possible to save the data in the Acquisition file. To do so, select the “Save this data in the Acquisition file” option at the bottom of the “Measurements” section.

4.6. CAMERA LENS

Prior to profiling a beam with a camera lens, one must adjust the *Pixel Multiplication Factor* of the lens (see section 5.2.8).

The “*Camera lens calibration*” section allows the user to calibrate the PC-Beamage software when a camera lens is used with the Beamage. This panel is accessible by clicking “*Calibrate*” in the “*Pixel Multiplication Factor*” section in the “*Setup*” panel or in the “*Show/Hide Options*” in the Ribbon.

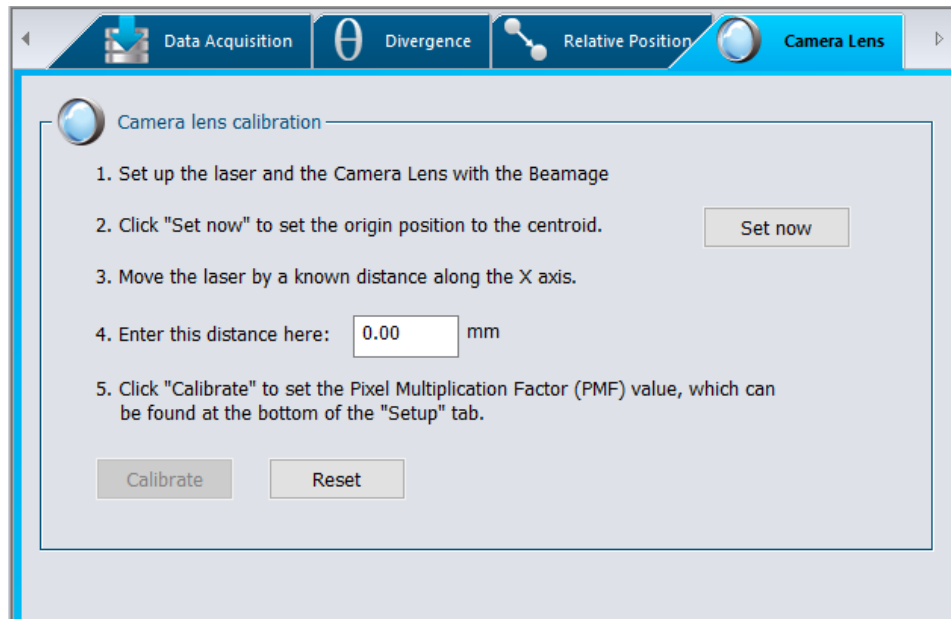

Figure 4-16 Camera Lens Calibration Section

1. Set up the laser and the camera lens with the Beamage.
2. Click on “*Set now*” to set the centroid to the current position
3. Then, move the laser source (or the Beamage camera) by a known distance along the X axis, parallel to the diffuser.

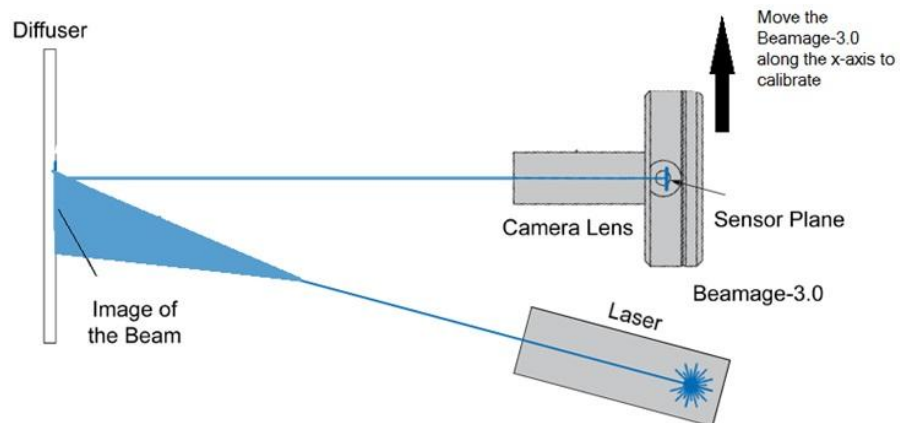

Figure 4-17 Camera Lens Calibration Moving Direction

4. Enter this distance (in mm) in the appropriate box and press enter.
5. Finally, click on the “Calibrate” button to automatically set the *Pixel Multiplication Factor (PMF)* value found in the bottom of the “*Setup*” tab. Once the PMF is set, the beam dimensions will be adjusted to compensate for the magnification of the camera lens (Beam Tracking Display).

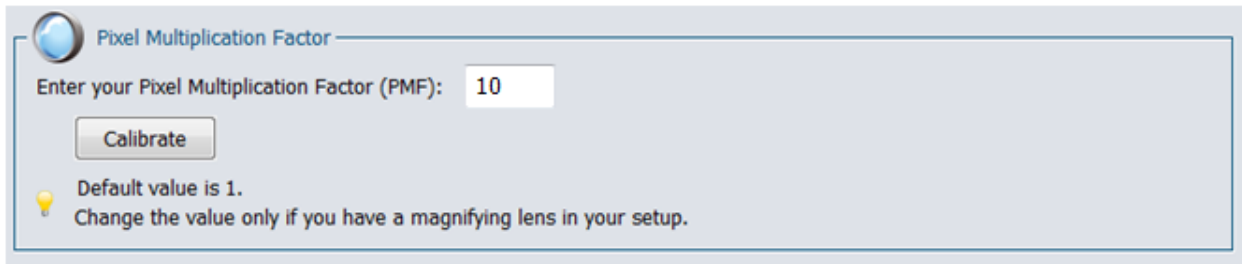

Figure 4-18 Pixel Multiplication Factor Section

6. To return to original values for the *Pixel Multiplication Factor*, click on “*Reset*”

4.7. FIXED CROSSHAIR

4.7.1.Center Setup

To activate the fixed crosshair center option, go to the “*Home*” panel, in the “*Main Controls*” section and choose the *Fixed* option for the crosshair center. This will automatically open the “*Fixed Crosshair*” panel.

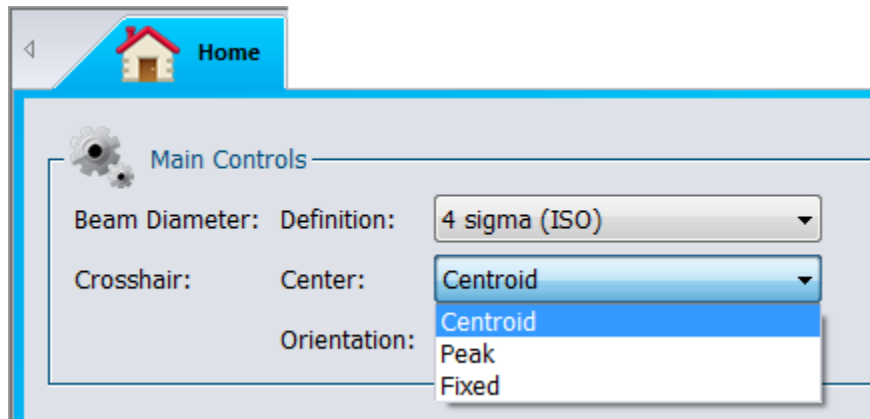

Figure 4-19 Fixed Crosshair Center Section

The “*Center Setup*” section, which displays the coordinate system of the sensor on the right side, allows the user to select the parameter that will be considered as the origin of the crosshairs (0,0).

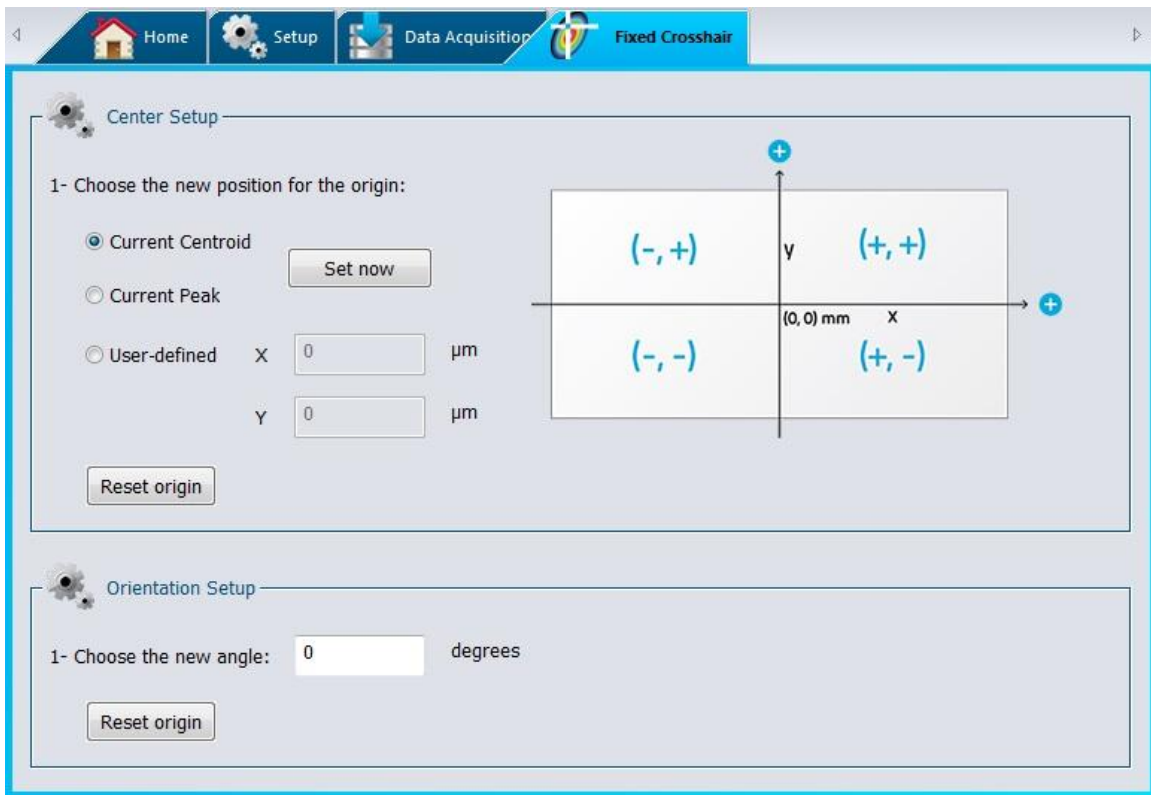

Figure 4-20 Fixed Crosshair Section

By selecting “Centroid” and clicking “Set now”, the user chooses to position the origin of the crosshairs at the calculated centroid position (center of energy). By selecting “Peak” and clicking “Set now”, the user chooses to position the origin of the crosshairs at the calculated peak energy position (highest measured value). The option “User-defined”, allows the user to manually enter the origin of the crosshairs at a defined position in both the X and Y axes.

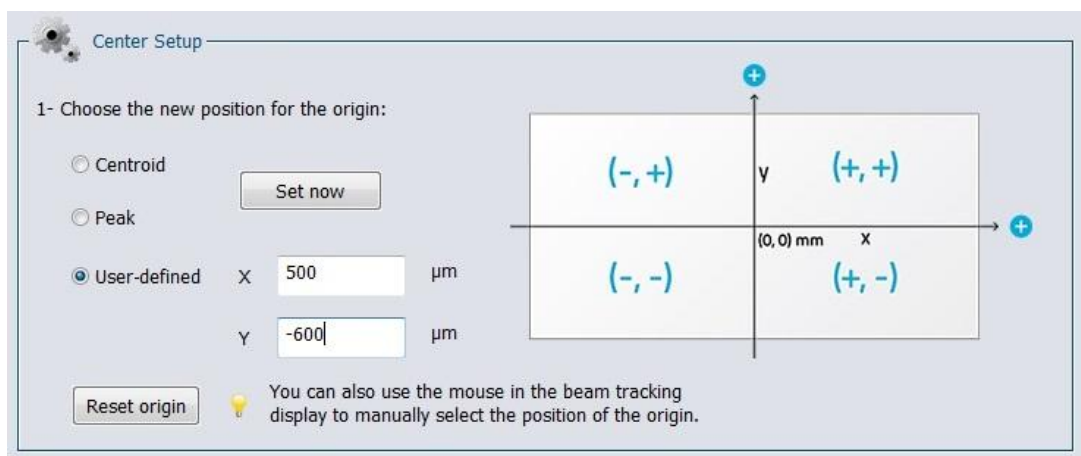

Figure 4-21 User-Defined Origin

Once the origin of the crosshairs is determined by the user, the software will be able to see the crosshairs from this particular origin in the 2D Display.

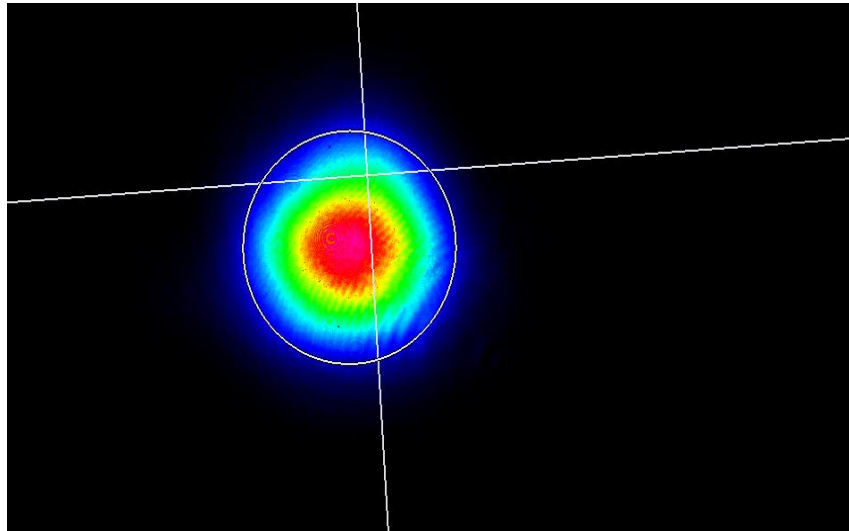

Figure 4-22 Fixed Crosshairs at Peak Position in the 2D Display

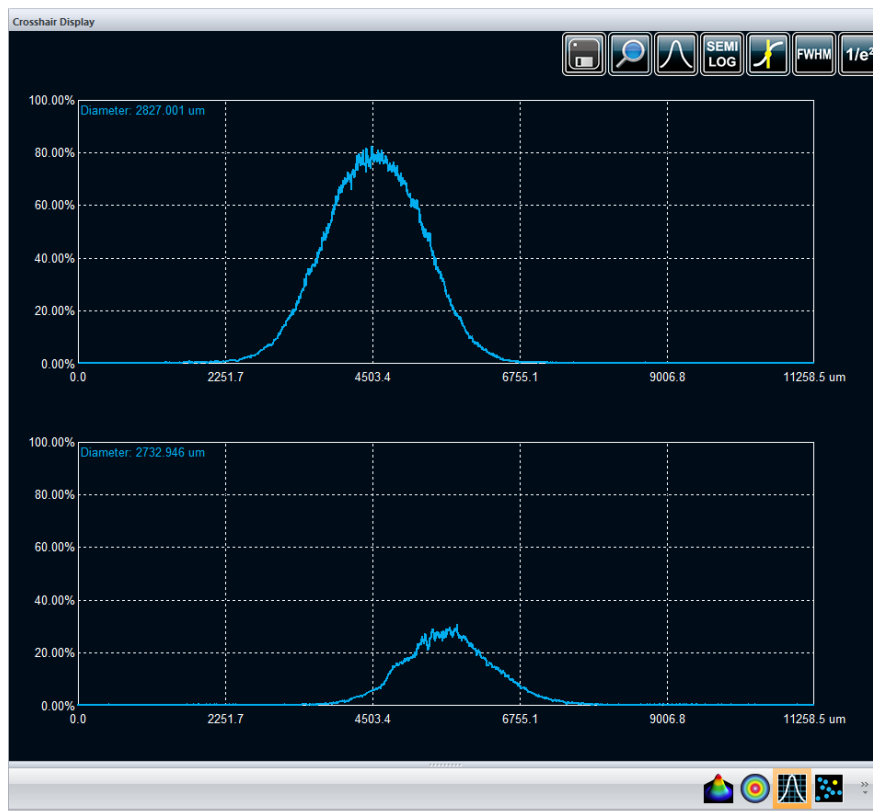

Figure 4-23 Fixed Crosshairs at Peak Position in the Crosshair Display

It is also possible to set the origin in the 2D display. When the *Fixed* option is active in the “Home” panel, the picker tool will be activated in the 2D Display. To use it and set the origin of the fixed crosshair center, click on the toolbar button and then, click on the position into the image.

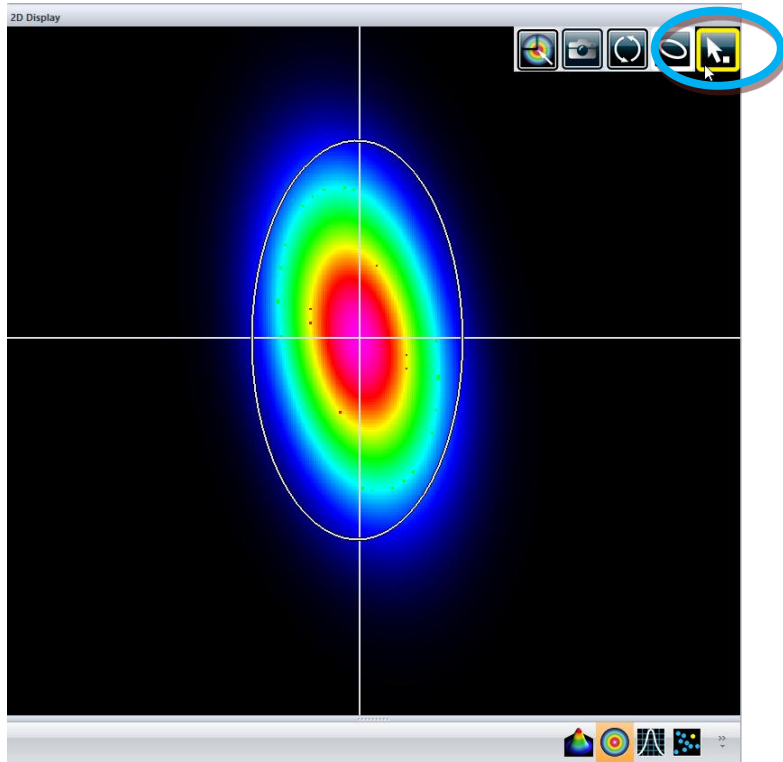

Figure 4-24 Fixed Crosshairs picker tool in the 2D Display

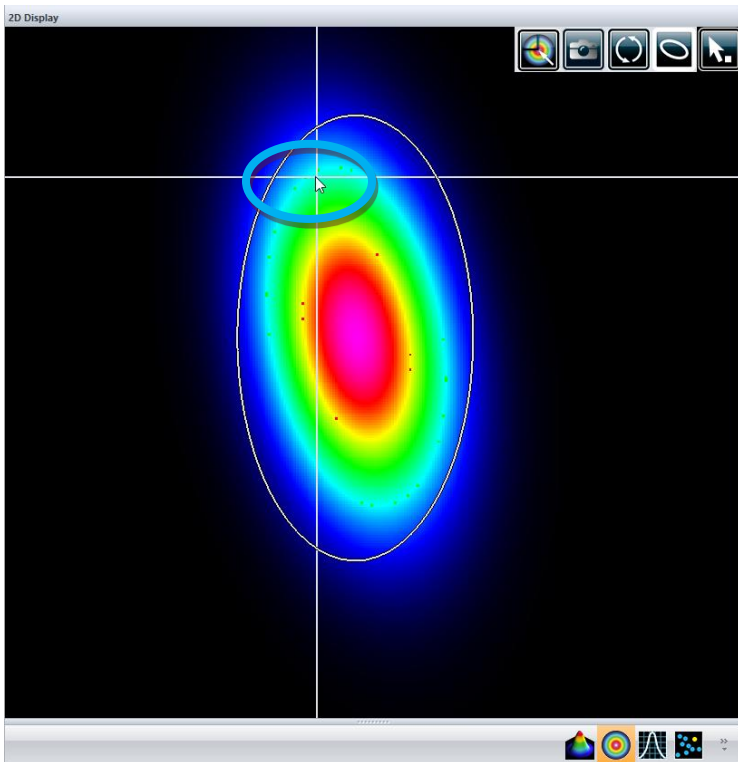

Figure 4-25 Fixed Crosshairs picking position in the 2D Display

4.7.2. Orientation Setup

To activate the fixed crosshair orientation option, go to the “Home” panel, in the “Main Controls” section and choose the *Fixed* option for the crosshair orientation. This will automatically open the “Fixed Crosshair” panel.

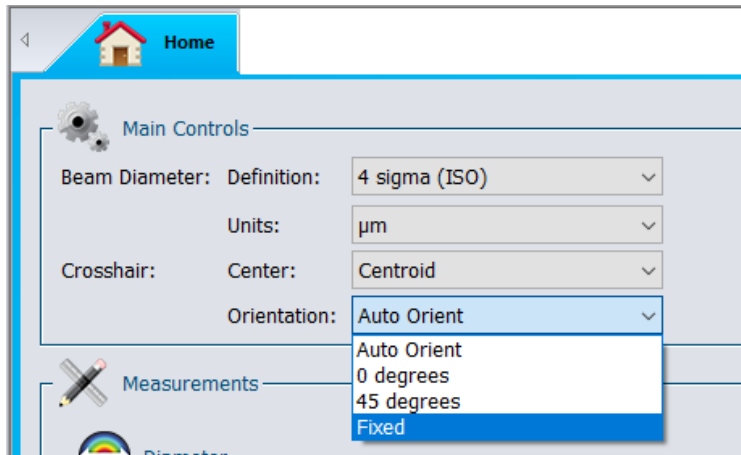

Figure 4-26 Fixed Crosshair Orientation Section

The “*Orientation Setup*” section allows the user to set the crosshair orientation. Once the orientation of the crosshairs is determined by the user, the software will be able to see the crosshairs at this particular angle with respect to the sensor’s main axes.

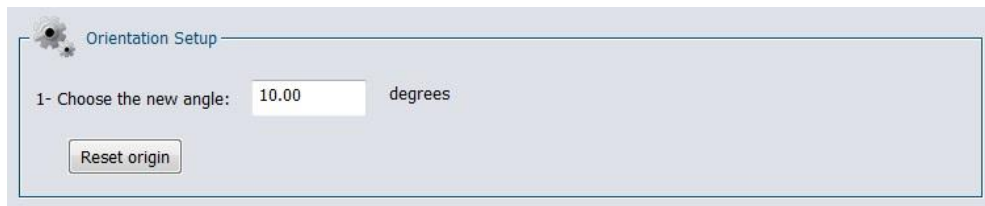

Figure 4-27 User-Defined Crosshair Orientation

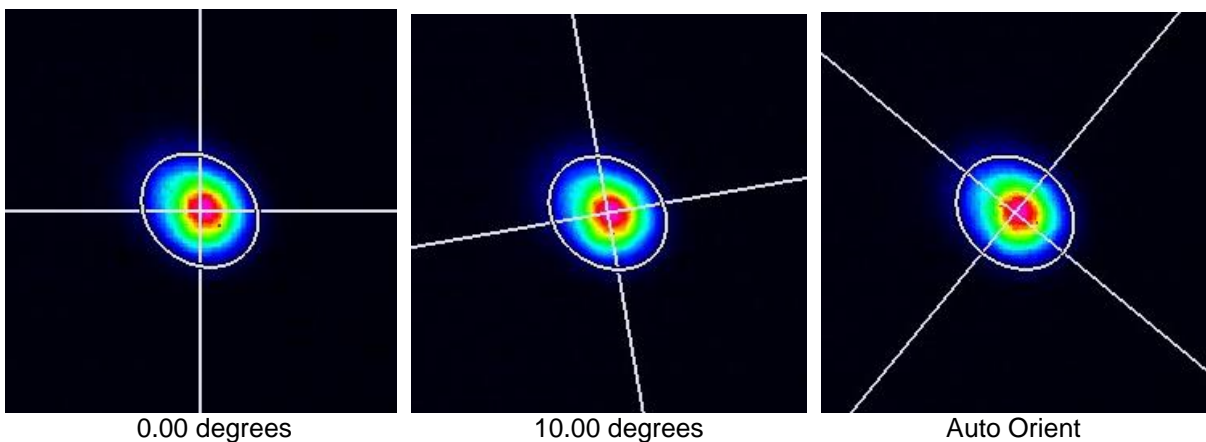

Figure 4-28 Different Crosshair Orientations for the Same Beam

5. DISPLAY PANEL

PC-Beamage offers four different display modes to view and analyze the laser beam.



3D Display: A real time display of the beam intensity in a 3D representation.



2D Display: A real time display of the beam intensity in a 2D representation.



Crosshair Display: A real time display of the beam's shape along the crosshairs.



Beam Tracking Display: A real time display of the beam's position stability

To choose the desired display mode, click on the corresponding icon in the lower control bar under the display panel.

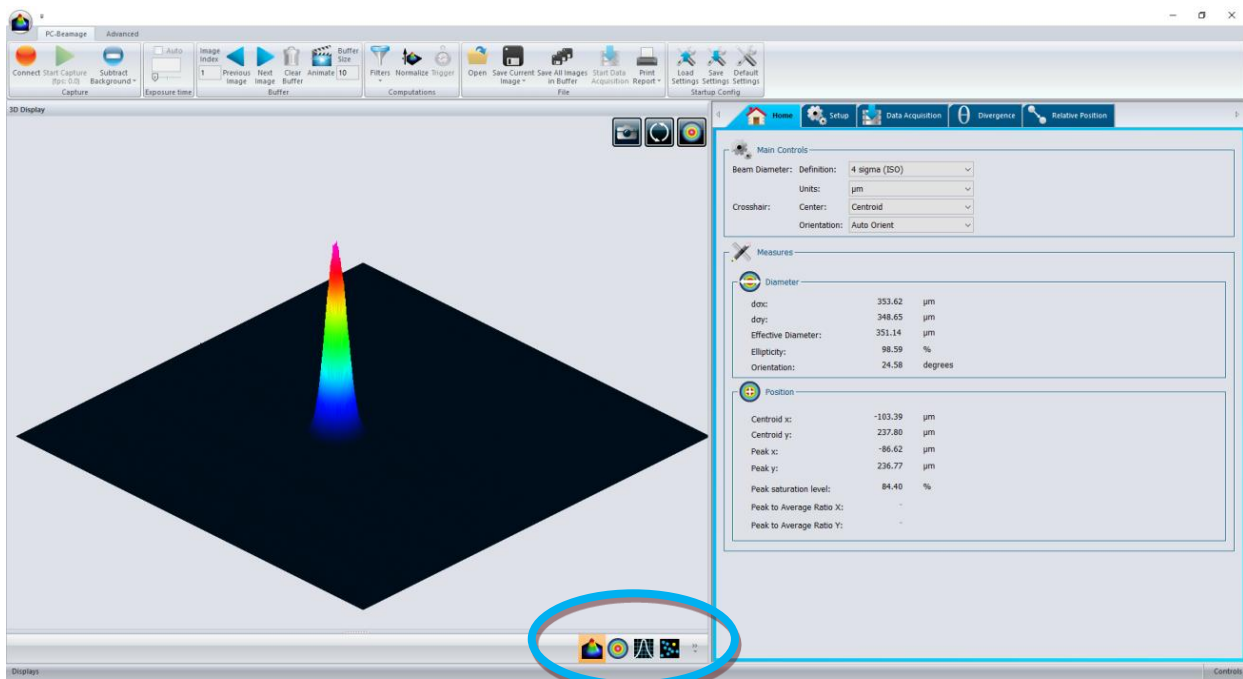

Figure 5-1 Display Panel

5.1. 3D DISPLAY

The 3D Display represents the beam's intensity in three dimensions. False coloring is added to increase the contrast. The color legend used for the various intensity levels is available in the "Main Controls" ribbon (refer to section 3.11.1).

To rotate the image, hold down the left button on the mouse and move the mouse. The scroll button on the mouse zooms the image in or out. It is also possible to zoom in the image by pressing the "+" key on the keyboard and similarly, it is possible to zoom out the image by pressing the "-" key on the keyboard. Pressing the Ctrl button while holding down the left mouse button will pan the 3D image along its Y axis. Doing the same procedure with the Shift button pans the 3D image along its X axis.

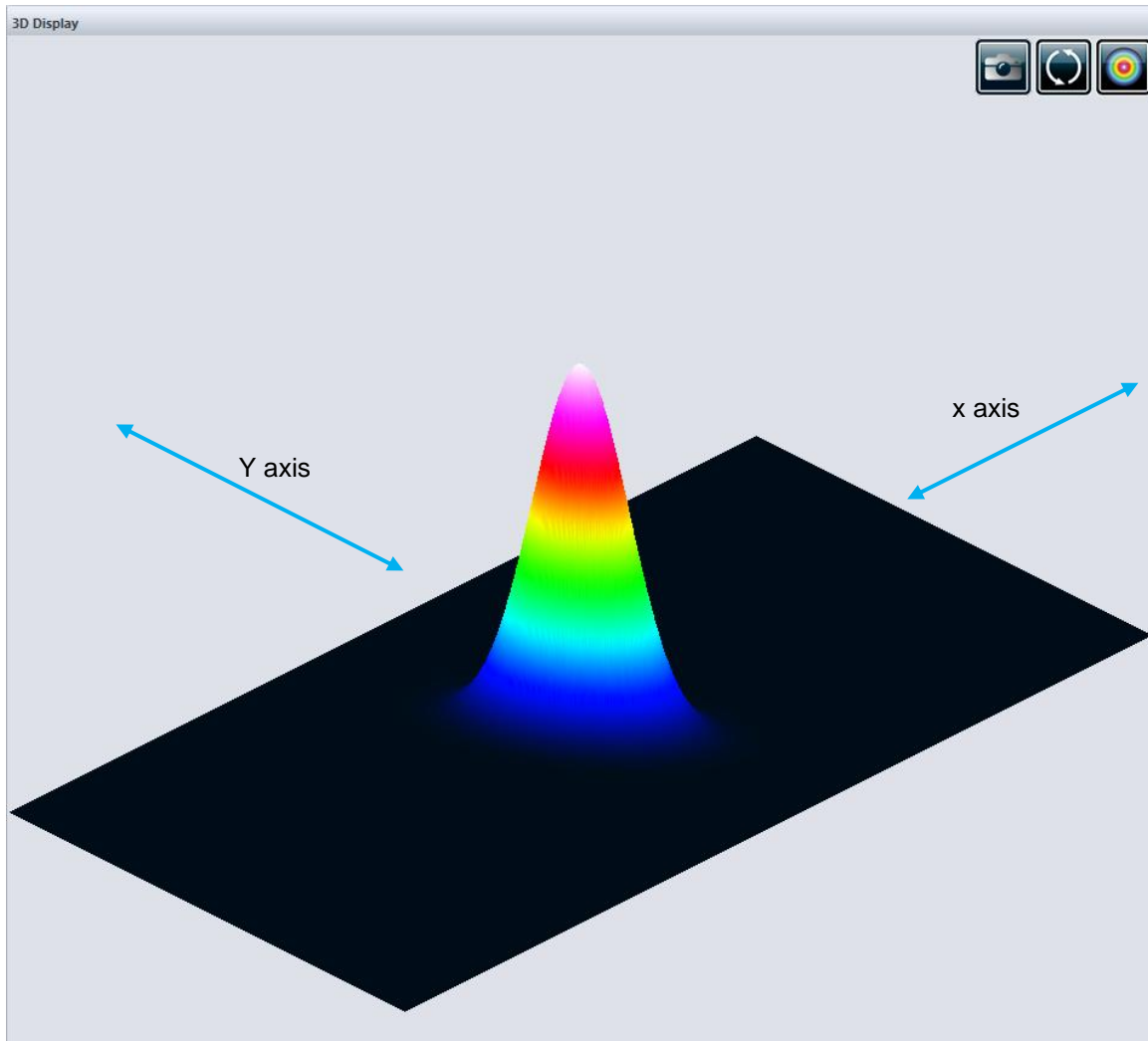

Figure 5-2 3D Display

5.1.1.3D Display: Controls

The toolbar buttons on the upper right corner control the 3D image.



Print Screen: Saves a *.BMP or *.JPG image of the current 3D display.



Reset View: Resets the display to its original parameters.



Top View: Views the 3D image from the top, creating a top-view projection.

5.2. 2D DISPLAY

The 2D Display represents the beam's intensity in two dimensions. False coloring is added to increase the contrast. The color legend used for the various intensity levels is available in the “*Main Controls*” ribbon (refer to section 3.11.1). The 2D display also features the crosshairs (set to the major and minor axis or along specified angles).

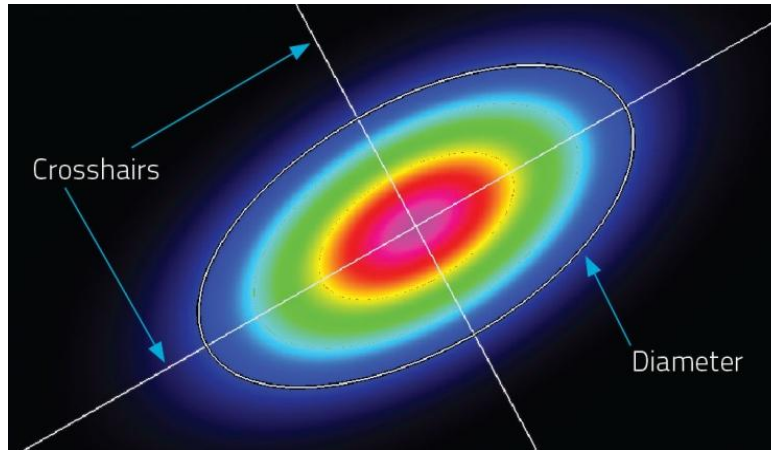

Figure 5-3 2D Display Showing Crosshairs and Diameter Positions

To optimize the software's performance, the resolution of the 2D image is downsampled when the Beamage is streaming. Nonetheless, the computation is done on all transferred pixels. For images larger than 1000x1000 only 1/16 pixels are displayed, for images larger than 500x500 only 1/4 pixels are displayed and for smaller images all pixels are displayed. When the Beamage is stopped or in the animate mode, all pixels are always displayed regardless of the image size.

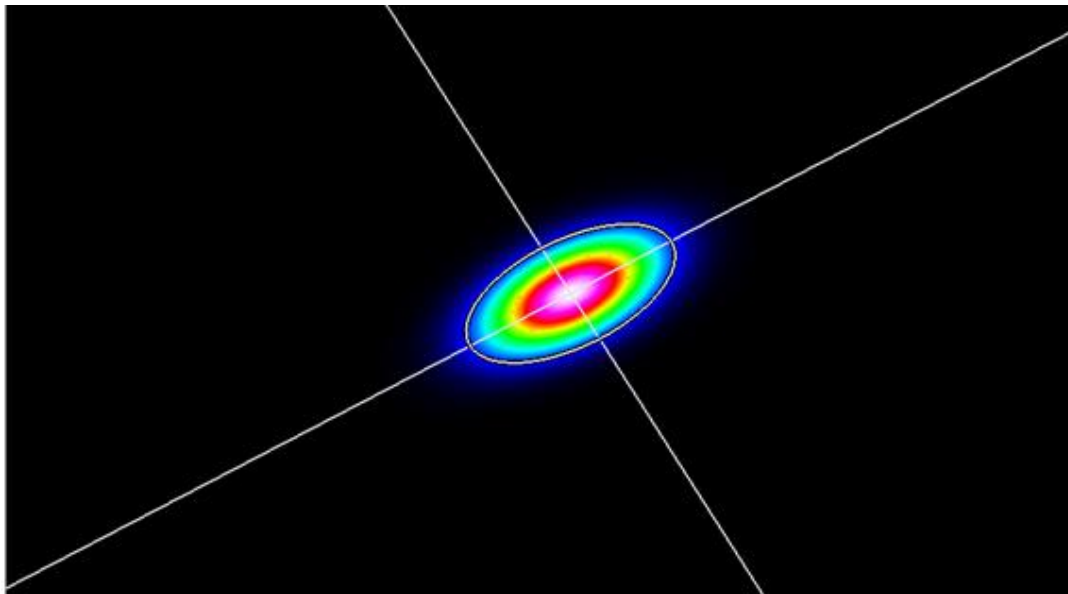

Figure 5-4 2D Display

To translate the image, hold down the left button on the mouse and move the mouse. The scroll button on the mouse zooms the image in or out.

Keyboard Controls:

The position and the zoom level of the 2D

- Zoom in :  + 
- Zoom out :  + 
- Left translation :  + 
- Right translation :  + 
- Up translation :  + 
- Down translation :  + 

5.2.1.2D Display: Controls

The toolbar buttons on the upper right corner control the 2D image.



Print Screen: Saves a *.BMP or *.JPG image of the current 2D display.



Reset View: Resets the view settings to its original parameters.



Show/Hide Diameter: Displays the ellipse corresponding to the beam diameter (refer to section 4.1.1.1).



Select Active Area: Selects with cursor an active area.



Set Fixed Crosshair Origin: Sets the fixed crosshair origin, please refer to section 4.7.1



Grayscale: Changes the color display to shades of gray.

5.3. CROSSHAIR DISPLAY

The “*Crosshair Display*” plots cross-sectional graphs of the beam along the crosshairs. The crosshairs position and orientation are defined in the “*Home*” tab (refer to section 4.1.1.2)

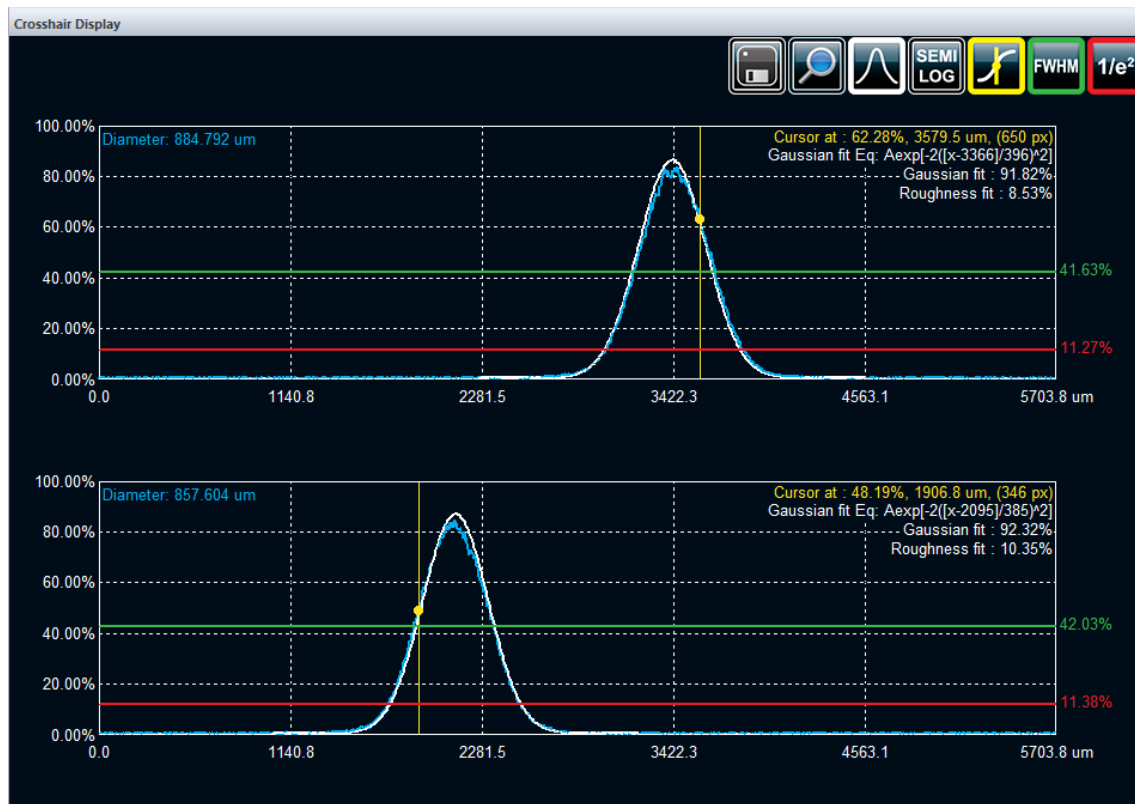

Figure 5-5 Crosshair Display

5.3.1. Crosshair Display: Controls

The toolbar buttons on the upper right corner control the crosshair graphs.



Save: Saves the crosshair information in a *.TXT file. If the “*Gaussian Fit*” was activated, the crosshair information of the Gaussian fit will also be saved in the file.



Zoom: Enables zooming in on each graph separately.. Zooming in can be done by selecting an area with the left mouse button. Double-clicking the image returns it to the original state.



Gaussian Fit: Shows/Hides the best fitted Gaussian along the experimental curve. Refer to section 3.4.2 for more information.



Semi-Log: Transforms the linear graphs to semi-logarithmic graphs to enhance the details in the low intensity parts of the beam.



Cursor Position: Shows/Hides a cursor on each graph with their intensity, position and pixel number value in the graph’s upper right corner. The cursors are positioned by clicking on the desired spots with the left mouse button.



FWHM: Shows/Hides the level corresponding to the half maximum value.



1/e²: Shows/Hides the level corresponding to the 1/e² value.

5.3.2. Gaussian Fit

The “*Gaussian Fit*” function fits the best Gaussian curve on the experimental data. When the “*Gaussian Fit*” is activated, the following pieces of information are displayed in the upper right part of the graph.

5.3.2.1. The Gaussian equation

The first information to be displayed is the equation of the fitted Gaussian. The Gaussian equation is defined by:

$$f(x) = Ae^{\left[-2\left(\frac{x-c}{w}\right)^2\right]}$$

where w is the beam’s radius, c its centroid.

5.3.2.2. The Gaussian Fit factor

The Gaussian Fit factor is defined as:

$$\text{Gaussian fit (\%)} = \left[1 - \frac{\sum |E_i - E_i^a|}{\sum E_i^a}\right] \times 100\%$$

where E is the experimental curve and E^a is the theoretical Gaussian curve.

The closer to 100%, the better the Gaussian fit.

5.3.2.3. The Roughness Fit factor

The Roughness Fit factor is the maximum deviation between the theoretical Gaussian curve and the measured curve, as defined by ISO13694:2000¹:

$$\text{Roughness fit (\%)} = \left[\frac{|E_i - E_i^a|_{max}}{E_{max}}\right] \times 100\%$$

where E is the experimental curve and E^a is the theoretical Gaussian curve.

The closer to 0%, the better the Gaussian fit.

¹ International Organization for Standardization, *ISO 13694 :2000 Laser and laser-related equipment – Test methods for laser beam power (energy) density distribution*, Geneva

5.4. BEAM TRACKING DISPLAY

The “*Beam Tracking Display*” shows the variation of the position of the centroid on the sensor. The yellow cross represents the last calculated centroid position while the blue dots represent the previous ones. A dot is added to the chart at each computation. The buffer can memorize as many as 2000 calculations. The buffer is circular, which means that once it is full, it replaces the oldest value in memory by a new one. The mean position of all the centroid positions is represented by a red cross and the origin position is represented by a large white cross with a green center.

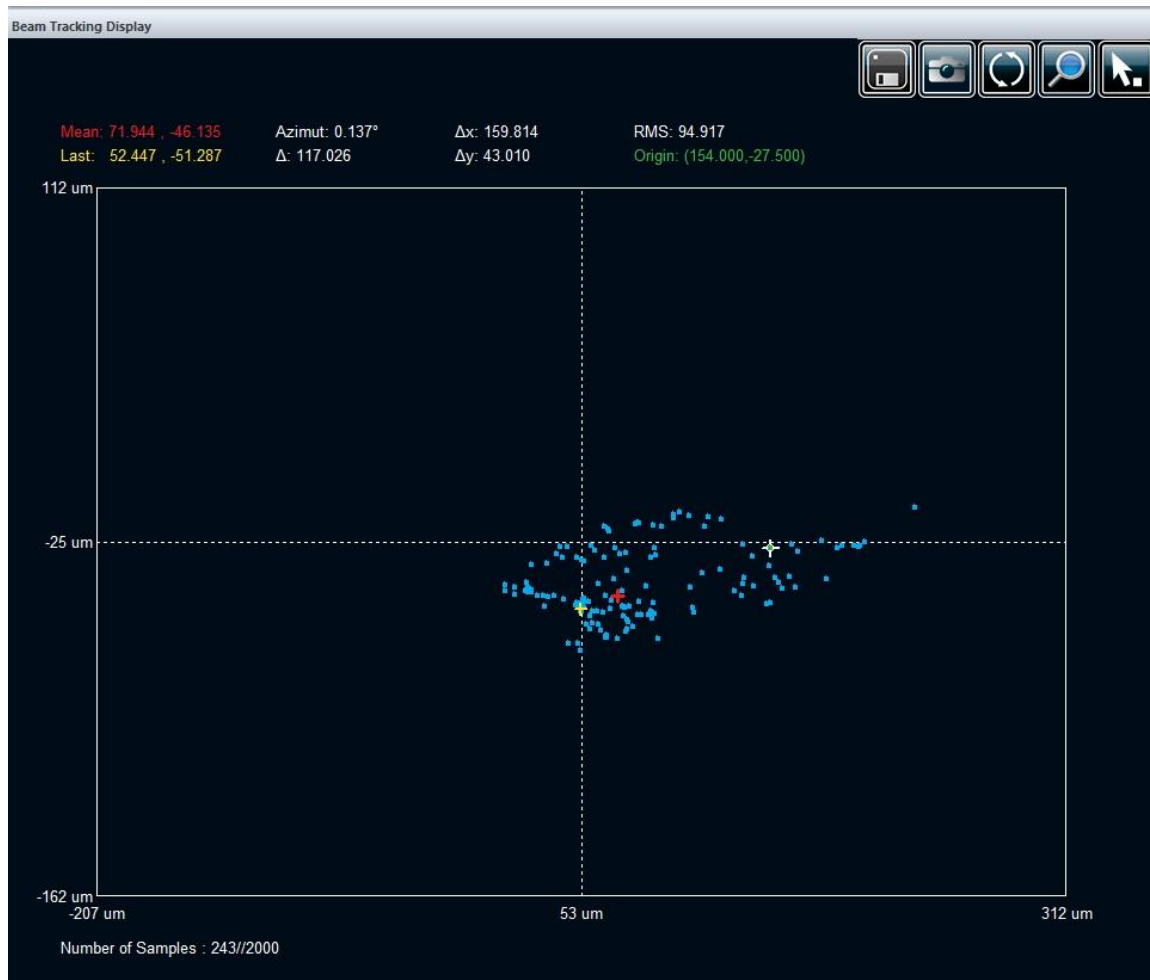

Figure 5-6 Beam Tracking Display

Useful ISO 11670 compliant values appear above the chart. They give an indication on how much the beam drifts from its mean position.

- *Mean*: Coordinates of the mean position of the centroid.
- *Last*: Coordinates of the last calculated position of the centroid.
- *Azimuth*: Orientation for which the drift is maximal.
- Δ : Overall beam positional stability
- Δx : Beam positional stability in the azimuth direction.
- Δy : Beam positional stability perpendicularly to the azimuth.
- *RMS*: RMS standard deviation value of the centroid's position (not ISO measurement)
- *Origin*: Relative position of the origin

The beam positional stability values are based on the standard deviation concept¹. Small values represent small deviations and a good stability.

For tracking more than 2000 points, please refer and use the acquisition feature: 3.6.4 Start Data Acquisition. Please refer to Appendix A for ISO mathematical definitions of the quantities listed above.

5.4.1. Beam Tracking Display: Controls

The toolbar buttons on the upper right corner control the beam tracking plot.



Save: Saves all the centroid coordinates available in the buffer in a *.TXT file.



Print Screen: Saves a *.BMP or *.JPG image of the current beam tracking display.



Reset Buffer: Erases all the data from the buffer and clears the chart.



Zoom: Activates the zoom. Zooming can be done by selecting an area with the left mouse button and de-zooming can be done by double-clicking the image.



Set Origin Point: Sets the origin point (0, 0) of the sensor for the relative positioning, please refer to section 3.8.3.

¹ International Organization for Standardization, *ISO 11670:2003 Laser and laser-related equipment – Test methods for laser beam parameters – Beam positional Stability*, Geneva

6. M^2 MODE

The M^2 factor can be considered as a quantitative indicator of laser beam quality. In terms of propagation, it is an indicator of closeness to an ideal Gaussian beam at the same wavelength. Please refer to Appendix B for the theory about M^2 quality factor.

Using a minimalist setup, it is possible to use a Beamage camera and readily available tools to perform manual M^2 calculations. Using a lens and moving the camera along the z-axis, you can use the M^2 Manual routine in the Beamage software to obtain ISO 11146 M^2 measurements. See the Beamage-M2 user manual for details on how to proceed for a manual measurement.

Automated M^2 measurements can be performed on the Beamage-M2 system. See the Beamage-M2 User Manual under the Help menu for more information.

Note that all the information about M^2 measurement using a Beamage camera or a Beamage-M2 device is presented in the Beamage-M2 User Manual.

7. THIRD PARTY COMMANDS

7.1. PC-BEAMAGE LABVIEW VIS AND .NET COMMANDS

The PC-Beamage Software can be controlled from LabVIEW using the VI Library supplied by Gentec-EO. They are individual VIs to implement each of the supported control and measurement functions. It is also possible to create more Labview VIs using the LabVIEW commands.

Gentec-EO also offers .Net named pipes commands to allow you to create your own C++, C# or Visual Basic application. Named pipes can be used to provide communication between processes on the same computer or between processes on different computers across a network.

A VI example that demonstrates how to use the individual VIs to build a standalone LabVIEW application is available. Likewise, a C++ solution example program is available to demonstrate how to use the individual commands and build a standalone C++ application.

Before using the VIs or the commands, the PC-Beamage Software must be running, and the LabVIEW or .Net Pipeline must be opened (refer to section 3.8.6).

The Vis and commands can be grouped into 6 basic categories.

1. Connection Commands
2. Control Commands
3. Measurement Commands
4. Display Commands
5. Activation Commands
6. Miscellaneous Commands

Description	Available VI samples	Available commands for LabVIEW and .Net
Connection Commands		
Checks to ensure the required DLL file is present in the directory in which the LabVIEW VIs are located.	Verify DLL	
Connects to the LabVIEW pipeline opened by the PC-Beamage software.	Connect to PC Beamage	
Disconnects from the LabVIEW pipeline opened by the PC-Beamage software	Disconnect from PC Beamage	
Control Commands		
Stops the capture from the PC-Beamage software and the Beamage USB Camera. This is the same as pressing the Stop Capture button in the software.	Control Stop Capture.	*CTLSTOP
Starts the capture from the PC-Beamage software and the Beamage USB Camera. This is the same as pressing the Start Capture button in the software.	Control Start Capture.	*CTLSTART
Save the beam raw data information in the beamage.txt file.	Control Data Save	*CTLDATSAVE
Sets the Beam Diameter Definition Control in the PC-Beamage Software. This is the same as pressing the selecting the 4 Sigma (ISO) control in the software.	Control 4 Sigma.	*CTL4SIG
Sets the Beam Diameter Definition Control in the PC-Beamage Software. This is the same as pressing the selecting the FWHM control in the software.	Control FWHM.	*CTLFWHM
Sets the Beam Diameter Definition Control in the PC-Beamage Software. This is the same as pressing the selecting the 1/e ² along crosshairs (13.5%) control in the software	Control 10VRe ² .	*CTL1OVRE
Sets the Beam Diameter Definition Control in the PC-Beamage Software. This is the same as pressing the selecting the 86% effective diameter (D86) control in the software.	Control 86%.	*CTL86
Sets the Crosshair Center Control in the PC-Beamage Software. This is the same as pressing the selecting the Centroid control in the software	Control Centroid.	*CTLCENT
Sets the Crosshair Orientation Control in the PC-Beamage Software. This is the same as pressing the selecting the Auto Orient control in the software	Control Peak.	*CTLPEAK
Sets the Crosshair Orientation Control in the PC-Beamage Software. This is the same as pressing the selecting the Auto Orient control in the software.	Control Auto.	*CTLAUTO
Sets the Crosshair Orientation Control in the PC-Beamage Software. This is the same as pressing the selecting the 0 degrees control in the software.	Control Zero.	*CTLZERO
Sets the Crosshair Orientation Control in the PC-Beamage Software. This is the same as pressing the selecting the 45 degrees control in the software	Control 45.	*CTL45
Sets the Exposure Time Control in the PC-Beamage Software. This is the same as pressing the selecting the Auto exposure time control in the software.	Control Auto Exposure.	*CTLETAUTO

Sets the Exposure Time Control in the PC-Beamage Software. This is the same as pressing the selecting the Manual exposure time control in the software.	Control Manual Exposure.	*CTLETMANU
Sets the Save Current Image Control in the PC-Beamage Software. This is the same as pressing Save Current Image control in the software. Image format will be *.BMG.	Control Image Save	*CTLIMGSAVE
Sets the Save Current Image Control in the PC-Beamage Software. This is the same as pressing Save As Current Image control in the software. Image format will be *.TXT.	Control Text Save	*CTLXTSAVE
Save the current 2D display image into MyDocuments/Gentec-eo/beamage.bmp.	Control Bitmap Save	*CTLBMPSAVE
Save the current 2D display image into MyDocuments/Gentec-EO/beamage.jpg.	Control Jpeg Save	*CTLJPGSAVE
Measurement Commands		
The measurement for the Diameter and Position. Running the selected commands returns the reading from the software.		
Returns the beam's effective diameter measurement	Measure Effective Diameter	*MEAEFFDIA
Returns the beam's ellipticity measurement	Measure Ellipticity	*MEAEELLIP
Returns the beam's orientation measurement	Measure Orientation	*MEAORIEN
Returns the beam's peak saturation level measurement	Measure Peak Saturation	*MEAPKSAT
Returns the beam's diameter closest to the X axis	Measure Diameter, X Axis	*MEASIXAX
Returns the beam's diameter closest to the Y axis	Measure Diameter, Y Axis	*MEASIYAX
Returns the beam's major axis measurement	Measure Major Axis	*MEAMAJAX
Returns the beam's minor axis measurement	Measure Minor Axis	*MEAMINAX
Returns the X divergence measurement	Measure X Divergence	*MEAXDIVER
Returns the Y divergence measurement	Measure Y Divergence	*MEAYDIVER
Position Commands		
Position commands have separate VIs for the X and Y measurements. Running the selected command returns the reading from the software.		
Returns the beam's X centroid measurement and returns the beam's Y centroid measurement	Measure X Centroid and Measure Y Centroid	*MEACENTX and *MEACENTY
Returns the beam's X FWHM clip level measurement and returns the beam's Y FWHM clip level measurement	Measure X FWHM and Measure Y FWHM	*MEAFWHMX and *MEAFWHMY
Returns the beam X $1/e^2$ diameter measurement and returns the beam Y $1/e^2$ diameter measurement	Measure X $10VRE^2$ Measure Y $10VRE^2$	*MEA10VREX and *MEA10VREY
Returns the beam's X Gaussian Equation and returns the beam's Y Gaussian Equation	Measure X Gaussian Equation and Measure Y Gaussian Equation	*MEAEQUX and *MEAEQUY
Returns the beam's X Gaussian Fit and returns the beam's Y Gaussian Fit	Measure X Gaussian Fit % and Measure Y Gaussian Fit %	*MEAGFITX and *MEAGFITY
Returns the X peak to average measurement and returns the X peak to average measurement	Measure X Peak to Average and	*MEAPKRAX and *MEAPKRAY

	Measure Y Peak to Average	
Returns the X peak measurement and returns the Y peak measurement	Measure X Peak and Measure Y Peak	*MEAPEAKX and *MEAPEAKY
Returns the X roughness fit measurement and returns the Y roughness fit measurement	Measure X Roughness Fit and Measure Y Roughness Fit	*MEARFITX and *MEARFITY
Returns the X or Y graph's intensity level at cursor position in %	Measure X Intensity Level % and Measure Y Intensity Level %	*MEAPERX and *MEAPERX -
Returns the X or Y graph's cursor position	Measure X Cursor Position and Measure Y Cursor Position	*MEAPOSX and *MEAPOSY
Track Display Measurement Commands These measurements are on the TRACK Display. Use the Display commands to choose the TRACK Display before requesting measurement data from the software.		
Returns the X coordinate of the last measured centroid and returns the Y coordinate of the last measured centroid	Measure X Last and Measure Y Last	*MEALASTX and *MEALASTY
Returns the X coordinate of the mean position of all measured centroids and Returns the Y coordinate of the mean position of all measured centroids	Measure X Mean and Measure Y Mean	*MEABEAMX and *MEABEAMY
Returns the beam's X positional stability in the azimuth direction and returns the beam's Y positional stability perpendicularly to the azimuth direction	Measure X Delta and Measure Y Delta	*MEADELTX and *MEADELTY
Returns the orientation for which the drift is maximal.	Measure Azimuth	*MEAAZMTH
Returns the overall beam positional stability	Measure Delta	*MEADELTA
Returns the number of samples in the Track Display buffer	Measure Number of Samples	*MEANSMPL
Returns the RMS standard deviation value of the centroid's position (not ISO measurement)	Measure RMS	*MEARMS
Display Commands These VIs decide which display the PC-Beamage software will use. Using them is the same as pressing one of the four display buttons on the bottom of the software screen.		
Switches to the 2 D display screen	Display 2D.	*DIS2D
Switches to the 3 D display screen.	Display 3D	*DIS3D
Switches to the Crosshair Display screen	Display XY.	*DISXY
Switches to the Beam Track display screen.	Display TRACK.	*DISTRACK

Activate Commands.		
<p>These commands select which measurement the PC-Beamage software will use. Using them is the same as pressing one of the four buttons on the top of the Crosshair Display software screen. For LabVIEW users, the Cursor Control Button is not implemented in this release of LabVIEW VIs. You must run each of these VIs at least one time before requesting the respective measurement.</p>		
Running this has the same effect as pressing the Gaussian button in the Crosshair Display.	Activate Gaussian	*ACTXYGAUSS
Running this has the same effect as pressing the SEMI LOG button in the Crosshair Display.	Activate LOG.	*ACTXYLOG
Running this has the same effect as releasing the SEMI LOG button in the Crosshair Display	Activate LIN.	*ACTXYLIN
Running this has the same effect as pressing the FWHM button in the Crosshair Display.	Activate FWHM.	*ACTXYFWHM -
Running this has the same effect as pressing the 1/e2 button in the Crosshair Display.	Activate 1OVRE.	*ACTXYE2
Running this has the same effect as pressing the Subtract background in the ribbon.	Activate Background	*ACTBACK
Running this has the same effect as pressing the Subtract background in the ribbon	Deactivate Background	*DACTBACK
Running this has the same effect as pressing the Trigger button in the ribbon	Activate Trigger	*ACTTRIG
Running this has the same effect as pressing the Divergence button in the ribbon	Activate Divergence	*ACTDIVER
Running this has the same effect as pressing the Gray Scale button in the 2D Display	Activate Gray Scale	*ACTGSCALE
Running this has the same effect as pressing the Normalize in the ribbon	Activate Normalize	*ACTNORMALI
Running this has the same effect as pressing the Filter and Despeckle in the ribbon	Activate Despeckle Filter	*ACTDESPECF
Running this has the same effect as pressing the Filter and IR in the ribbon	Activate IR Filter	*ACTIRF
Running this has the same effect as pressing the Filter and Smoothing in the ribbon	Activate Smoothing Filter	*ACTSMOOTF
Miscellaneous VIs		
Returns the PC-Beamage software version.	Query PC-Beamage Version	*VER
Returns the serial number of the camera that is currently connected to the software	Query Serial Number.	*MEASNM
Returns the current exposure time setting of the camera Available from PC-Beamage 1.08.00	Query Exposure Time	*MEAEXPTIME
Use this command to send the desired manual time. Ex: To set the exposure time to 12.34 ms, send *SNDMAN1234	Send Exposure Time.	*SNDMAN
Send the focal length value for divergence calculation towards PC-Beamage software	Send Focal Length Divergence	*SNDFLDIVER
Interfaces with the DLL file to read data from the software.	Read PC Beamage	
Interfaces with the DLL file to write data to the software.	Write PC Beamage.	
This VI is used to determine the behavior of the example application when it exits. If the example is being run in the LabVIEW Development environment, it will stay in memory and stay loaded on exit. If it is being run as an executable file, it will unload and clean memory when it exits.	Stay or Go.	

7.2. LABVIEW EXAMPLE

The VIs have all been used to create an example software. The front panel of this example is shown below.

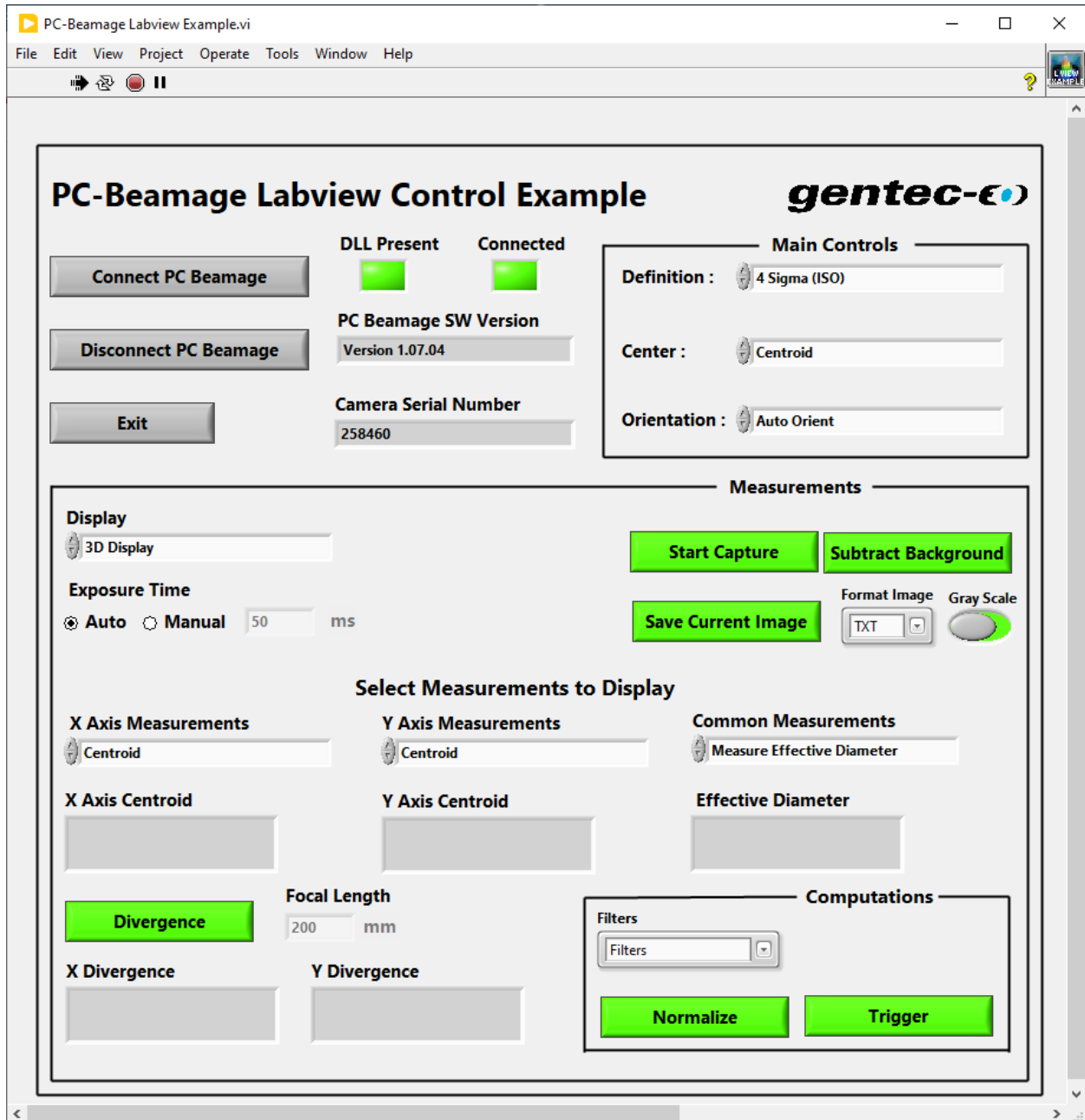

Figure 7-1 Beamage LabVIEW Example

The example is written to be easy to use and understand so as to aid in the development of custom LabVIEW software. It uses an event structure to show the various controls. To use the example:

1. Copy the VIs into the folder of your choice, along with the supplied DLL file.
2. Start LabVIEW and run the example VI.

3. The VI will check to ensure the DLL is present. A warning will be issued if it cannot be located, and the required location will be displayed. Place the DLL in that location.
4. Plug a Beamage Camera into a USB port on the PC in use. Start PC-Beamage and let it connect to the camera.
5. Under the Show/Hide Options menu item, select Start LabVIEW Pipeline. The PC-Beamage software will verify the connection. You may now minimize the PC-Beamage software as LabVIEW can now control the functions (refer to section 3.8.6).
6. Press the Connect PC Beamage button on the LabVIEW software. The Connected LED will turn on. The VI will ask the PC-Beamage for some information, and the software Version and Serial Number indicators will appear.
7. Press the Start Capture button. The Selected measurements will activate. Use the Main, Display, Activate buttons, and Measurements controls to select the desired measurements. The Activate buttons are only visible when the Crosshair Display is selected.
8. Pressing Disconnect or Exit will automatically stop all measurements and close the LabVIEW pipeline.



Warning

If integrating LabView VIs into your own project, every DLL Write command (such as in Write PC Beamage 64 bit DLL.vi) must be followed by a subsequent Read command (such as Read PC Beamage 64 bit DLL.vi) to clear the internal buffer and to ensure the command was executed without error, see Figure 7-2 for an example.

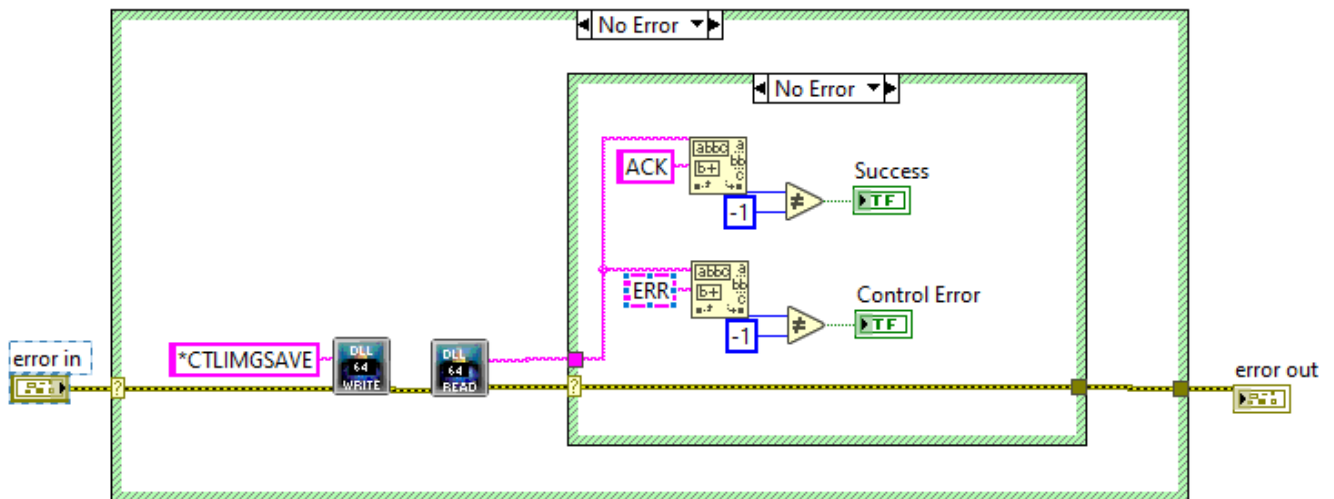

Figure 7-2 VI Example

7.3. .NET EXAMPLE

The Beamage_.Net_Example_V1.00.08.zip solution is a C++ standalone application to show how to use the PC-Beamage's .Net commands supplied by Gentec-EO.

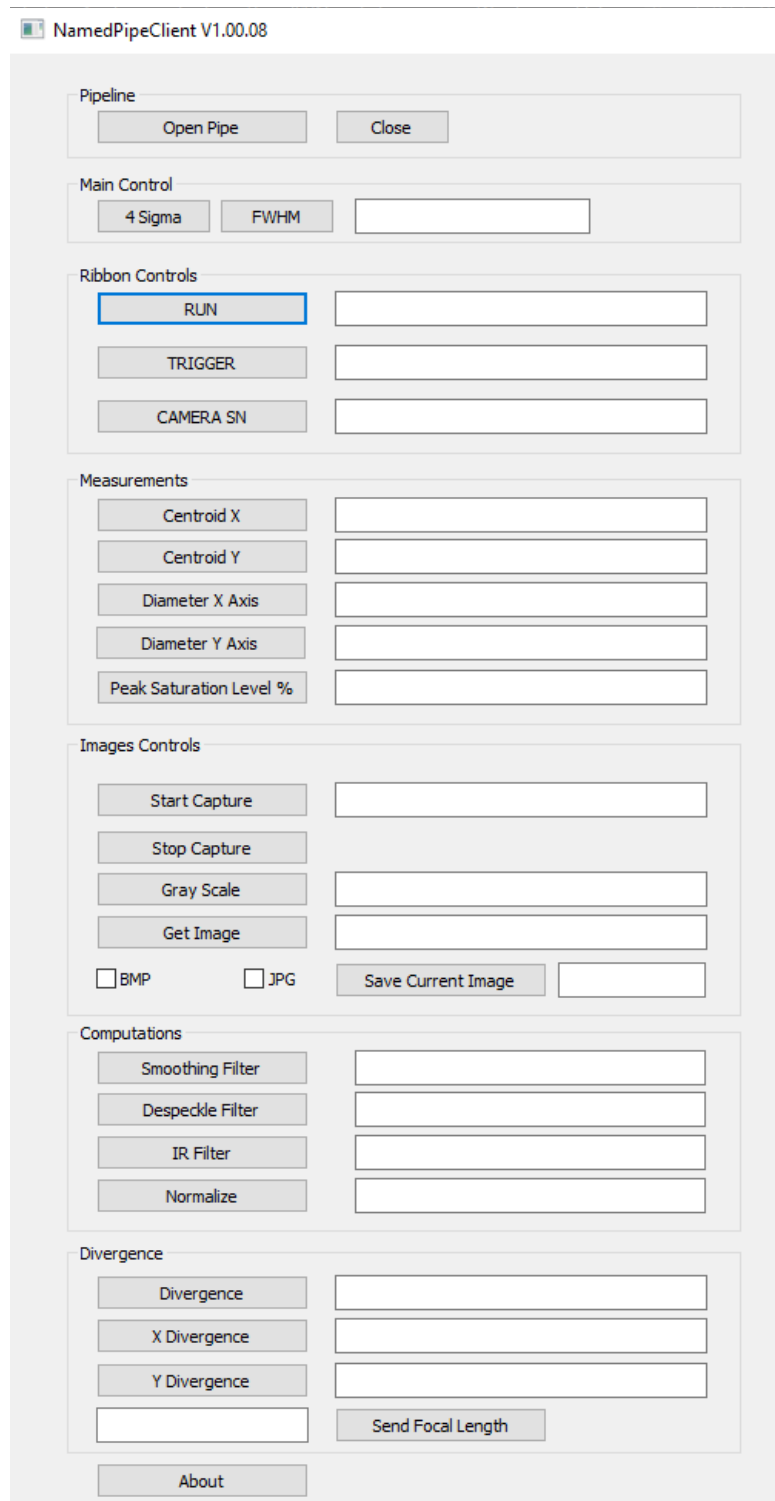

Figure 7-1 Beamage C++ Standalone Example

The example is written to be easy to use and understand so as to aid in the development of custom C++ software. It uses an event structure to show the various controls. To use the example:

1. Compile and run the NamedPipeClient.sln.
2. Plug a Beamage Camera into a USB port on the PC in use. Start PC-Beamage and let it connect to the camera.
3. Under the Show/Hide Options menu item, select Start .Net Pipeline. The PC-Beamage software will verify the connection. You may now minimize the PC-Beamage software as the application can now control the functions (refer to section 3.8.6).
4. Click the *Open Pipe* to start the communication between the application and the PC-Beamage software.
5. Click on the different buttons to try the different commands.
6. You will find all the example code in the NamedPipeClientDlg.cpp file.
7. End by clicking Close.

8. TROUBLESHOOTING AND TIPS

- 1) While trying to install PC-Beamage, it is possible that the installation of Microsoft Visual C++ 2015-2019 Redistributable (x86) is required. Beamage Installer will do this installation for you, but if this is not possible, an error message will be displayed when PC-Beamage starts,

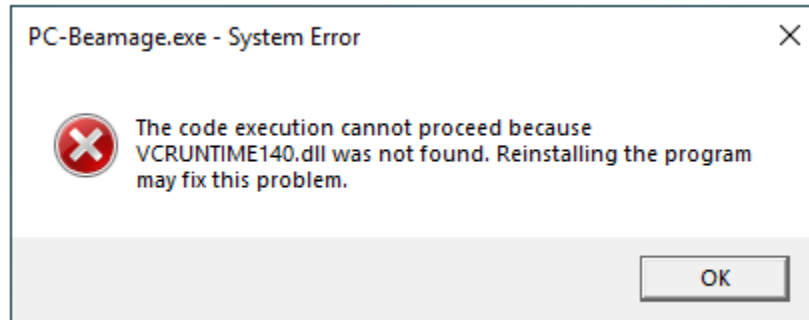

Figure 9-1 Missing DLL file Error Message

You can try an alternative installation of PC-Beamage and the missing dll file, to do this, please follow these steps:

- 1) Open the Beamage Installer.
- 2) Use the keyboard shortcut **“CTRL+SHIFT+I”** to launch the alternative installation.

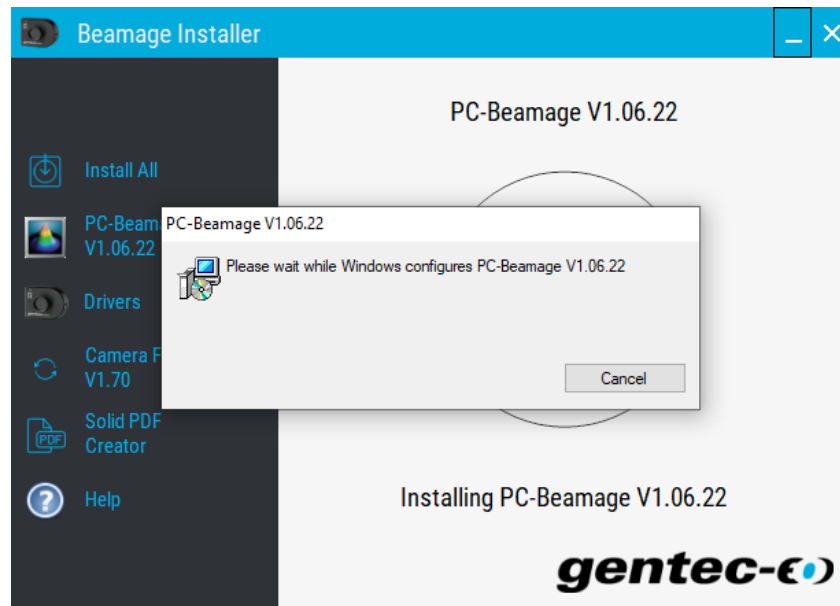

Figure 9-2 Keyboard Shortcut CTRL+SHIFT+I



Warning

Make sure you do not have another version of PC-Beamage installed on your computer, see **Figure 9-3**, and if so, please uninstall it before using the keyboard shortcut.

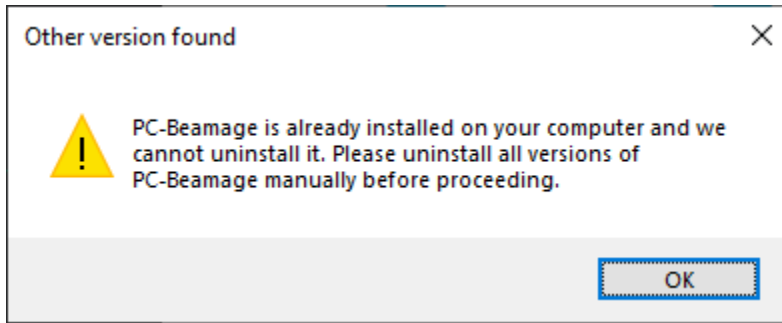

Figure 9-3 Other Version Found Message

- 3) Wait for the PC-Beamage installation to complete.
- 4) Follow the suggested steps for the dll file installer, see Figure 9-4

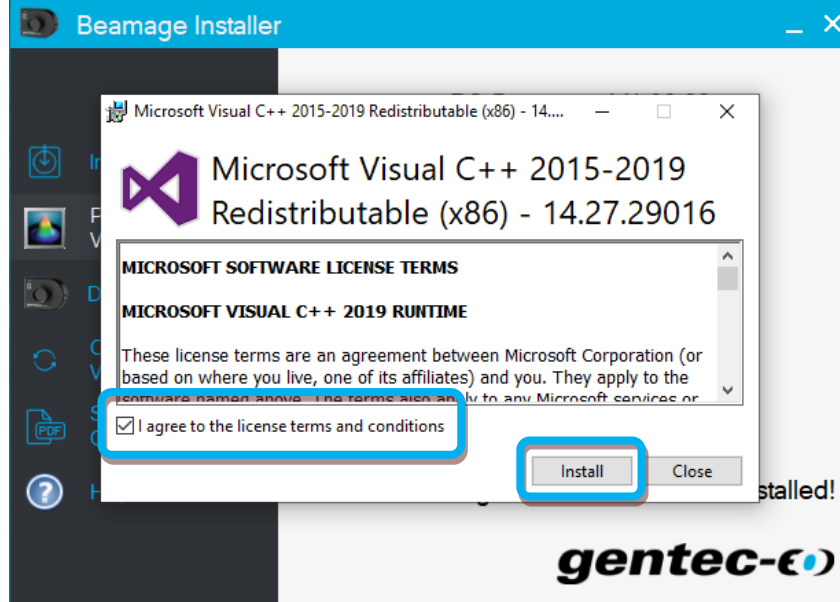

Figure 9-4 Microsoft Visual C++ Redistributable 2015-2019 (x86)

After these steps, PC-Beamage will open automatically and you can use the software.



Tip

You can download the missing dll file using the link below:
32 bits: [Microsoft Visual C++ 2015-2019 \(x86\)](#)

Or by visiting the Microsoft website, **Visual Studio 2015, 2017 and 2019** section:
[Support Microsoft](#)

2) Beamage is not detected

Make sure the Beamage is connected to a USB 3.0 Super Speed port. The Beamage will work if plugged directly in a USB 2.0 port at a slower transfer rate.

On modern computers with USB-A and USB-C ports, we recommend connecting the Beamage in one of three ways, trying them in the order listed:

1. Option 1: Connect the Beamage to your PC via the cable (#103642) in a USB-A 3.0 SuperSpeed port;
2. Option 2: Use the USB-A to USB-C adapter (#205915) to connect the Beamage to a USB-C 3.0 SuperSpeed port;
3. Option 3: Use the powered USB3.0-HUB (#202829) to connect the Beamage to a USB-A 3.0 SuperSpeed port on your PC.

Close the software application, disconnect and reconnect the USB 3.0 to the Beamage and open the software application. The LED indicator on the Beamage should blink in green and then in red before turning on green. If the LED does not turn on at the software's startup or if it does not turn on completely, please contact your Gentec-EO representative or contact us at service@gentec-eo.com.

3) The display area is completely white

Press the "Refresh" button and the display should come back.

4) Changing the optics in front of the Beamage

Because the Beamage's sensor does not have a cover glass, it is very sensitive to dust. Change the optics in a clean environment and put the Beamage's aperture facing down to minimize the dust.

5) Small black spots appear on the image

If these small black spots do not change place even if you rotate the attenuation filter, it is probably dust on the sensor. **DO NOT TOUCH** the surface of the chip to remove the dust as this will damage the sensor. **AT YOUR OWN RISK**, you can use an oil-free air jet to blow the dust away or contact your Gentec-EO representative.

6) It is not possible to start an acquisition. It keeps opening a warning message indicating that 0 GB is available on hard drive

This is probably due to the fact the path in/ which the PC-Beamage was not installed in the default C:\Program Files\GENTEC-EO\PC-Beamage directory.

7) There is no serial number displayed in the camera

- Please close the PC-Beamage software program, wait a couple of seconds and open the PC-Beamage again.

- If the problem persists, please verify in Window's Task Manager if there is only one PC-Beamage.exe instance running. If more than one are running, end all processes and open PC-Beamage again.
- If the problem persists, please disconnect the Beamage and connect it again.
- If the problem persists, please contact your Gentec-EO representative or contact us at service@gentec-eo.com.

8) The detected serial number is 000000

This happens when you connect a Beamage for the first time in a new USB port. The drivers need to be installed each time a new Beamage is plugged for the first time in a new USB port. When this happens, the PC-Beamage software often opens before the drivers are installed, indicating a 000000 serial number. Close the PC-Beamage software and restart the application.

9) The 10 bit adc level is not available even when the Beamage is connected to a usb 3.0 port

The 10-bit ADC level is only available when using a USB 3.0 port. If it is not available even when connected on a USB 3.0 port, reboot the computer. If it is still not available, it is very likely that the USB-3.0 is damaged and unusable. In that case, we strongly recommend not using this USB-3.0 with the Beamage camera, it could have a negative impact on the communication stability.

For more information, please contact your Gentec-EO representative or contact us at service@gentec-eo.com.

10) Do not disconnect the Beamage while it is streaming

The Beamage must not be disconnected when it is streaming.

11) Tips to increase the frame rate

The Beamage's frame rate greatly depends on the computer's performances. Here are a few tips to increase the frame rate:

- Use a USB-3.0 port;
- Use a computer with high performance (refer to PC Requirements);
- Use Windows 10 or 11;
- Do not use Filters (refer to 3.5.1);
- Do not use Image Averaging (refer to 4.2.3);
- For a large beam, use Pixel Addressing (refer to 4.2.5);
- For a small beam, use an Active Area as small as possible (3 times the beam diameter, refer to 4.2.4);
- Make sure you have a short and a manual exposure time;
- Do not stream multiple Beamage units simultaneously.
- Close any other software on your computer.
- Make a background subtraction;
- Use 1/e² beam diameter definition with 0 degree orientation;
- Deactivate 2D High Resolution (Advanced tab);
- Have a minimum of 30% of hard drive space available;
- Unplug any other peripheral device on your computer
- Disable any power saving settings on your computer

12) Low repetition-rate lasers

If your laser has a low repetition rate (< 250 Hz) you may experience problems with varying intensity levels. This happens because a different number of laser pulses are captured by the sensor per image. To have a constant intensity level, and therefore a constant and stable measurement, the same number of laser pulses should be captured during every frame.

One method that can help is using the external trigger function of the camera, which would synchronize the incoming laser pulses with the camera shutter, so that the same number of pulses are captured for every frame. This works in most cases but may still result in erratic measurements in some cases, such as with long exposure times or lasers with high jitter.

If the problem persists or if a trigger signal is not available, you can try to slightly reduce the exposure time of the camera, adjusting laser attenuation to keep a good saturation level (about 80% maximum intensity), and of course respecting the power and irradiance limits of the camera. The effect is to shorten the window of time in which unwanted laser pulses enter the camera.

13) Drag and drop for .bmg and .m2geo files

The drag-and-drop feature simplifies the process of importing .bmg and .m2geo files into the application. Drag the desired simple file from its location on your computer and drop it onto the application's interface. Please note that this drag-and-drop functionality is exclusively available on the 2D and 3D panels.



Tip

When double-clicking on .bmg and .m2geo files, the software will open and load the information from the file.

9. DECLARATION OF CONFORMITY



Application of Council Directive(s): 2014/30/EU The EMC Directive

Manufacturer's Name: Gentec Electro Optics, Inc.
 Manufacturer's Address: 445 St-Jean Baptiste, suite 160
 (Québec), Canada G2E 5N7

European Representative's Name: Laser Components S.A.S.
 Representative's Address: 45 bis Route des Gardes
 92190 Meudon (France)

Type of Equipment: Laser Beam Diagnostic Equipment.
 Model No.: Beamage
 Year of test & manufacture: 2012

Standard(s) to which Conformity is declared:
 EN 61326 :2005/EN 61326 : 2006/ Emission generic standard

Standard	Description	Performance Criteria
CISPR 11 :2009 +A1 2010	Industrial, scientific and medical equipment – Radio-frequency disturbance characteristics – Limits and methods of measurement	Class A
EN 61326 :2005/EN 61326 : 2006	Limits and methods of measurement of radio interference characteristics of information technology equipment. Testing and measurements of radiated emission	Class A
IEC 61000-4-2:2001	Electromagnetic compatibility (EMC) – Part 4: Testing and measurements techniques- Section 2: Electrostatic discharge.	Class B
IEC 61000-4-3:2002	Electromagnetic compatibility (EMC) – Part 4: Testing and measurements techniques- Section 3: Radiated, Radio Frequency immunity.	Class A

I, the undersigned, hereby declare that the equipment specified above conforms to the above Directive(s) and Standard(s).

Place: Québec (Québec)

Date : July 14, 2016

(President)

10. UKCA DECLARATION OF CONFORMITY



Application of Council Directive(s): 2014/30/EU The EMC Directive

Manufacturer's Name: Gentec Electro Optics, Inc.
 Manufacturer's Address: 445 St-Jean Baptiste, suite 160
 (Québec), Canada G2E 5N7

European Representative's Name: Laser Components S.A.S.
 Representative's Address: 45 bis Route des Gardes
 92190 Meudon (France)

Type of Equipment: Laser Beam Diagnostic Equipment.
 Model No.: Beamage
 Year of test & manufacture: 2012

Standard(s) to which Conformity is declared:
 EN 61326 :2005/EN 61326 : 2006/ Emission generic standard

Standard	Description	Performance Criteria
CISPR 11 :2009 +A1 2010	Industrial, scientific and medical equipment – Radio-frequency disturbance characteristics – Limits and methods of measurement	Class A
EN 61326 :2005/EN 61326 : 2006	Limits and methods of measurement of radio interference characteristics of information technology equipment. Testing and measurements of radiated emission	Class A
IEC 61000-4-2:2001	Electromagnetic compatibility (EMC) – Part 4: Testing and measurements techniques- Section 2: Electrostatic discharge.	Class B
IEC 61000-4-3:2002	Electromagnetic compatibility (EMC) – Part 4: Testing and measurements techniques- Section 3: Radiated, Radio Frequency immunity.	Class A

I, the undersigned, hereby declare that the equipment specified above conforms to the above Directive(s) and Standard(s).

Place: Québec (Québec)

Date : December 07, 2021

(President)

APPENDIX A. ISO11146 AND ISO11670 DEFINITIONS

The beam centroid coordinates are given by:

$$\bar{x}(z) = \frac{\int_{-\infty}^{\infty} \int_{-\infty}^{\infty} E(x, y, z) x dx dy}{\int_{-\infty}^{\infty} \int_{-\infty}^{\infty} E(x, y, z) dx dy}$$

$$\bar{y}(z) = \frac{\int_{-\infty}^{\infty} \int_{-\infty}^{\infty} E(x, y, z) y dx dy}{\int_{-\infty}^{\infty} \int_{-\infty}^{\infty} E(x, y, z) dx dy}$$

The beam widths are defined as an “*extent of a power density distribution in a cross section of beam based on the centered second order moments of the power density distribution.*”

The second order moments of power density distribution are given by:

$$\sigma_x^2(z) = \frac{\int_{-\infty}^{\infty} \int_{-\infty}^{\infty} E(x, y, z) (x - \bar{x})^2 dx dy}{\int_{-\infty}^{\infty} \int_{-\infty}^{\infty} E(x, y, z) dx dy}$$

$$\sigma_y^2(z) = \frac{\int_{-\infty}^{\infty} \int_{-\infty}^{\infty} E(x, y, z) (y - \bar{y})^2 dx dy}{\int_{-\infty}^{\infty} \int_{-\infty}^{\infty} E(x, y, z) dx dy}$$

$$\sigma_{xy}^2(z) = \frac{\int_{-\infty}^{\infty} \int_{-\infty}^{\infty} E(x, y, z) (x - \bar{x})(y - \bar{y}) dx dy}{\int_{-\infty}^{\infty} \int_{-\infty}^{\infty} E(x, y, z) dx dy}$$

The beam widths are given by:

$$d_{\sigma_x} = 2\sqrt{2} \left\{ (\sigma_x^2 + \sigma_y^2) + \gamma \left[(\sigma_x^2 - \sigma_y^2)^2 + 4(\sigma_{xy}^2)^2 \right]^{\frac{1}{2}} \right\}^{\frac{1}{2}}$$

$$d_{\sigma_y} = 2\sqrt{2} \left\{ (\sigma_x^2 + \sigma_y^2) - \gamma \left[(\sigma_x^2 - \sigma_y^2)^2 + 4(\sigma_{xy}^2)^2 \right]^{\frac{1}{2}} \right\}^{\frac{1}{2}}$$

where:

$$\gamma = \frac{\sigma_x^2 - \sigma_y^2}{|\sigma_x^2 - \sigma_y^2|}$$

The major axis is the width's maximum whereas the minor axis is the width's minimum.

The effective diameter of the beam is an “*extent of a circular power density having an ellipticity greater than 0.87. [...] If the ellipticity is larger than 0.87, the beam profile may be considered to be of circular symmetry at that measuring location and the beam diameter can be obtained from.*”

$$d_{\sigma} = 2\sqrt{2}(\sigma_x^2 + \sigma_y^2)^{1/2}$$

The beam ellipticity is the “*ratio between the minimum and maximum widths*”

The beam orientation is the “*angle between the x-axis [...] and that of the principal axis of the power density distribution which is closer to the x-axis.*” From this definition, the angle is comprised between 45° and -45°.

$$\varphi(z) = \frac{1}{2} \arctan \left(\frac{2\sigma_{xy}^2}{\sigma_x^2 - \sigma_y^2} \right)$$

The beam's divergences transformed by an aberration-free focusing element of focal length f are given by the following equations:

$$\theta_x = \frac{d_{\sigma_x}}{f}$$

$$\theta_y = \frac{d\sigma_y}{f}$$

$$\theta_\sigma = \frac{d\sigma}{f}$$

In the laboratory or usual system of coordinates (X',Y',Z'), the coordinates of the latest calculated position of the centroid for both X' and Y' axes are given by the following equations:

$$\bar{x}'(z) = \frac{\int_{-\infty}^{\infty} \int_{-\infty}^{\infty} E(x', y', z') x' dx' dy'}{\int_{-\infty}^{\infty} \int_{-\infty}^{\infty} E(x', y', z') dx' dy'}$$

$$\bar{y}'(z) = \frac{\int_{-\infty}^{\infty} \int_{-\infty}^{\infty} E(x', y', z') y' dx' dy'}{\int_{-\infty}^{\infty} \int_{-\infty}^{\infty} E(x', y', z') dx' dy'}$$

The coordinates of the mean position of all computed centroids for both X' and Y' axes are thus defined by the following equations, which are simple arithmetic means,

$$\bar{x}'_M = \frac{\sum_i \bar{x}'_i}{n}$$

$$\bar{y}'_M = \frac{\sum_i \bar{y}'_i}{n}$$

Where $\bar{x}'_i(z)$ and $\bar{y}'_i(z)$ are the centroid coordinates for X' and Y' axes already saved in the buffer, and n the number of computed centroid positions saved in the buffer.

The azimuth angle, which is the angle between the usual X' axis and all computed centroids, is given by the following equation:

$$\psi = \frac{1}{2} \arctan \left(\frac{2s_{\bar{x}\bar{y}}^2}{s_{\bar{x}}^2 - s_{\bar{y}}^2} \right)$$

where we have the following definitions:

$$s_x = \sqrt{\frac{\sum_i \bar{x}'_i^2}{n-1}}$$

$$s_y^2 = \frac{\sum_i (\bar{y}'_i - \bar{y}'_M)^2}{n-1}$$

$$s_{\bar{x}\bar{y}}^2 = \frac{\sum_i (\bar{x}'_i - \bar{x}'_M)(\bar{y}'_i - \bar{y}'_M)}{n-1}$$

In the beam axis coordinate system (X,Y,Z), the beam positional stability values in the azimuth direction (X) and perpendicularly to the azimuth direction (Y), which are 4 times the standard deviations of all computed centroid values, are given by the following equations:

$$\Delta_x(z) = 4s_x$$

$$\Delta_y(z) = 4s_y$$

The overall positional stability is given by:

$$\Delta(z) = 2\sqrt{2}s$$

In the previous 3 equations, the standard deviations are defined by the following equations:

$$s_x = \sqrt{\frac{\sum_i \bar{x}_i^2}{n-1}}$$

$$s_y = \sqrt{\frac{\sum_i \bar{y}_i^2}{n-1}}$$

$$s = \sqrt{\frac{\sum_i \bar{x}_i^2 + \bar{y}_i^2}{n-1}}$$

\bar{x}_i^2 and \bar{y}_i^2 are derived from \bar{x}'_i^2 and \bar{y}'_i^2 by transformation of coordinates. (X',Y',Z') is the usual or laboratory coordinate system and (X,Y,Z) is the beam axis coordinate system.

The RMS standard deviation value of the centroid position, which is not an ISO standard, is given by the following equation:

$$RMS = \sqrt{\left(\frac{\sum_i x_r^2 + y_r^2}{n}\right)}$$

where x_r^2 and y_r^2 are relative values.

APPENDIX B. M² QUALITY FACTOR THEORY

Understanding the M² Factor

The M² factor, which is unitless, can be considered as a quantitative indicator of laser beam quality. It indicates the deviation of the measured beam from a theoretical Gaussian beam of the same wavelength. It can mathematically be defined as the ratio between the Beam Parameter Product (BPP = beam waist radius (w_0) multiplied by divergence half-angle (θ)) of the measured beam with the theoretical Gaussian beam. Thus, for a single mode ideal TEM₀₀ theoretical Gaussian beam, the M² factor is exactly 1. Also, the beam parameter product (BPP) of the laser beam, represented by the product of a laser beam's divergence angle (half-angle) and the radius of the beam at its narrowest point (the beam waist), is always equal or greater to the ideal beam parameter product. An M² value very close to 1 indicates an excellent beam quality. This is associated with a low divergence and a good ability to focus. Multimode lasers have higher M² factors.

Propagation Parameters

In the following equations, “th” refers to theoretical values and “exp” to experimental or real values.

The beam waist is defined as the location along the beam propagation axis where the beam radius reaches its minimum value (see the Beam Propagation Diagram below). For a theoretical Gaussian beam, the beam radius $w_{th}(z)$ at any z position along the beam axis is given by the following equation:

$$w_{th}(z) = w_{0th} \sqrt{1 + \left(\frac{\lambda z}{\pi w_{0th}^2}\right)^2}$$

Where λ is the laser wavelength and w_{0th} the theoretical beam waist radius.

As depicted in the figure below, the theoretical Rayleigh length Z_{Rth} is the distance (along the propagation axis) between the beam waist and the position where the beam radius is $\sqrt{2}$ times larger than the beam waist (doubled cross-section).

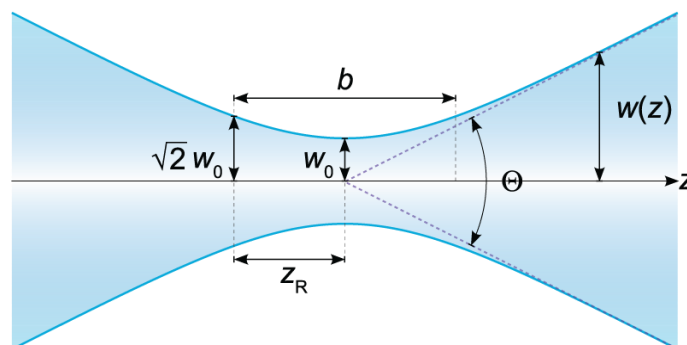

Figure B-1 Beam Propagation Diagram

Mathematically, it is given by the following equation:

$$z_{Rth} = \frac{\pi(w_{0th})^2}{\lambda}$$

Far from the beam waist, the beam expansion becomes linear and the theoretical divergence half-angle θ_{th} (half of the angle shown in the Beam Propagation Diagram) can be obtained by evaluating the limit of the beam radius' first derivative as the position tends towards infinity and with the small angle approximation:

$$\tan \theta_{th} \approx \theta_{th} = \lim_{z \rightarrow \infty} \frac{dw_{th}(z)}{dz} = \lim_{z \rightarrow \infty} \frac{d}{dz} w_{0th} \sqrt{1 + \left(\frac{\lambda z}{\pi(w_{0th})^2} \right)^2} = \frac{\lambda}{\pi w_{0th}}$$

For a laser beam that passes through a focusing lens of focal length f , the theoretical radius of the beam w_{fth} at the focal spot of the lens can be obtained by multiplying the beam divergence half-angle with the focal length f :

$$w_{fth} = f\theta_{th} = \frac{f\lambda}{\pi w_{0th}}$$

As mentioned, all of the equations above describe theoretical ideal Gaussian beams. However, they can describe the propagation of real laser beams if we slightly modify them using the M^2 factor, which can be mathematically defined by the following equations:

$$M^2 = \frac{\pi\theta_{exp}w_{0exp}}{\lambda} = \frac{\theta_{exp}w_{0exp}}{\theta_{th}w_{0th}} > 1 \quad \text{because} \quad \theta_{exp}w_{0exp} > \theta_{th}w_{0th} = \frac{\lambda}{\pi}$$

It is possible to see here why small M^2 values correspond to low experimental divergences and small experimental beam waist radiuses.

Using the M^2 factor, the experimental beam waist radius $w_{exp}(z)$ is therefore given by the following equation:

$$w_{exp}(z) = w_{0_{exp}} \sqrt{1 + z^2 / Z_{R_{exp}}^2}$$

The M^2 factor affects both beam waist radius and Rayleigh length, according to the following equations :

$$Z_{R_{exp}} = \frac{\pi w_{0_{th}}^2}{M^2 \lambda}$$

$$w_{0_{exp}} = M^2 w_{0_{th}}$$

The experimental half-angle divergence θ_{exp} and the experimental beam radius at the focal spot of the lens $w_{f_{exp}}$ are given by the following equations:

$$\theta_{exp} = \frac{M^2 \lambda}{\pi w_{0_{exp}}}$$

$$w_{f_{exp}} = f \theta_{exp} = \frac{f M^2 \lambda}{\pi w_{0_{exp}}}$$

We can now easily understand why small M^2 values correspond to low divergence beams with small focus spots.

Practical Measurement

In order to measure the M^2 factor, multiple slices of the beam within and beyond one Rayleigh length along the propagation axis must be considered. For each of them, the beam radius $w(z)$ is measured. A hyperbola, which recalls the beam radius equation, is then fitted with the results. The M^2 value is derived from that fit.

Since the distance range within which the measurements must be taken is too large (could be several meters), the use of a focusing lens is mandatory. It is also mandatory to comply with ISO standard. It helps to compress the slices of interest around the focal spot of the lens.

APPENDIX C. PC-BEAMAGE SOFTWARE

- 1) Download and run the *Beamage Installer*. The latest version can be downloaded from the *Downloads* tab at the bottom of the following web page: <https://www.gentec-eo.com/resources/download-center>.
- 2) Use the installer to install the PC-Beamage Software, see Figure C-1.

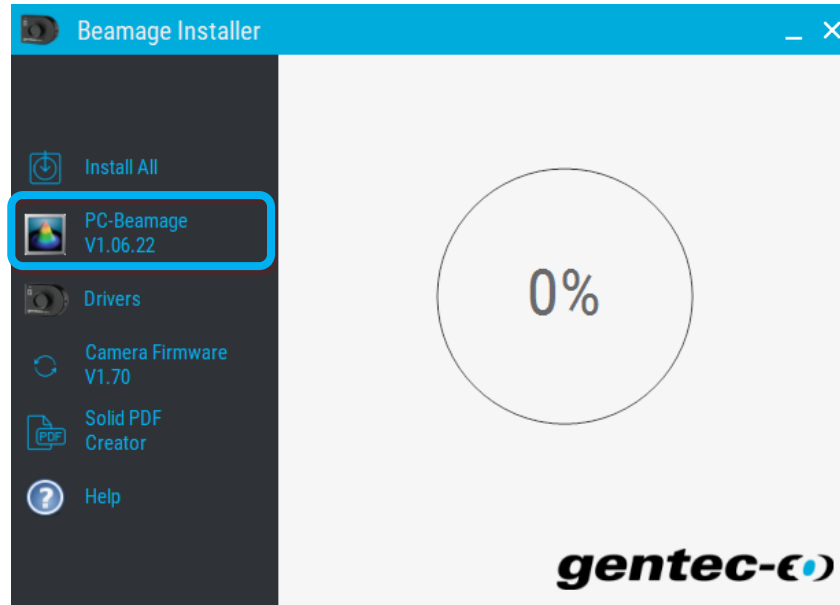

Figure C-1 Beamage Installer



Tip

For a first installation with the M² system, you can click on the “Install All” button. This button installs the PC-Beamage software, the Beamage camera drivers, and the driver for the translation stage, see **Figure C-2**

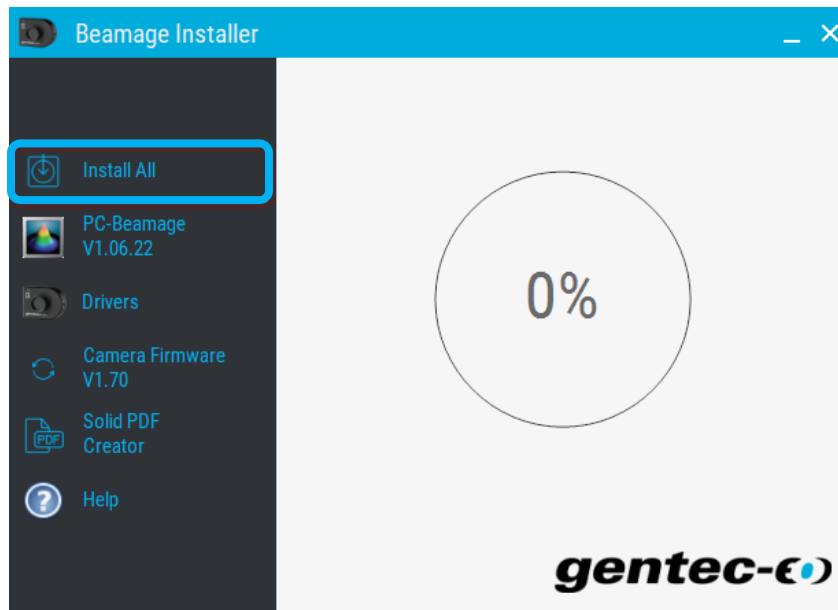

Figure C-2 Install All Button

APPENDIX D. BEAMAGE DRIVER INSTALLATION QUICK GUIDE

- 1) The latest available version of *PC-Beamage* must be installed before setting the drivers. It can be downloaded from the following web page: <https://www.gentec-eo.com/resources/download-center>
- 2) If the software is already installed on your computer, please make sure it is the latest available version of *PC-Beamage*. To do so, open the *PC-Beamage* software and click on *About*. Another window will appear and you will be able to know the software version.

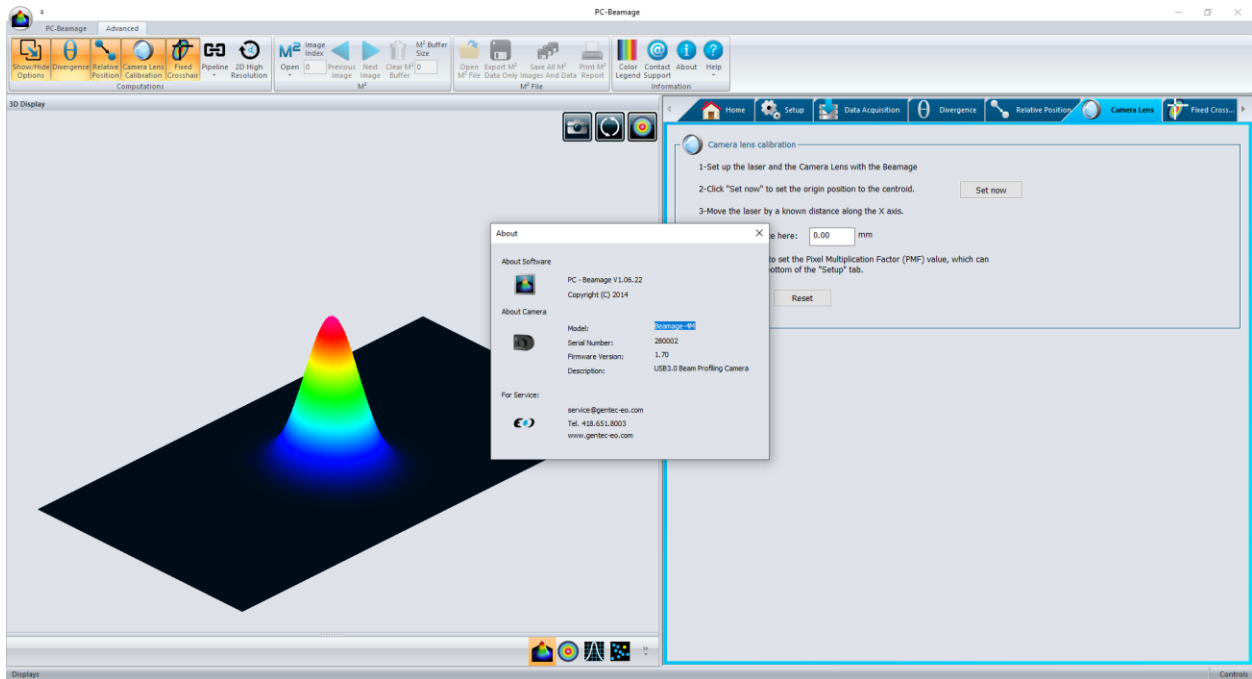

Figure D-1 PC-Beamage

- 3) Download and run the *Beamage Installer*. The latest version can be downloaded from the following web page: <https://www.gentec-eo.com/resources/download-center> .See Figure D-3.

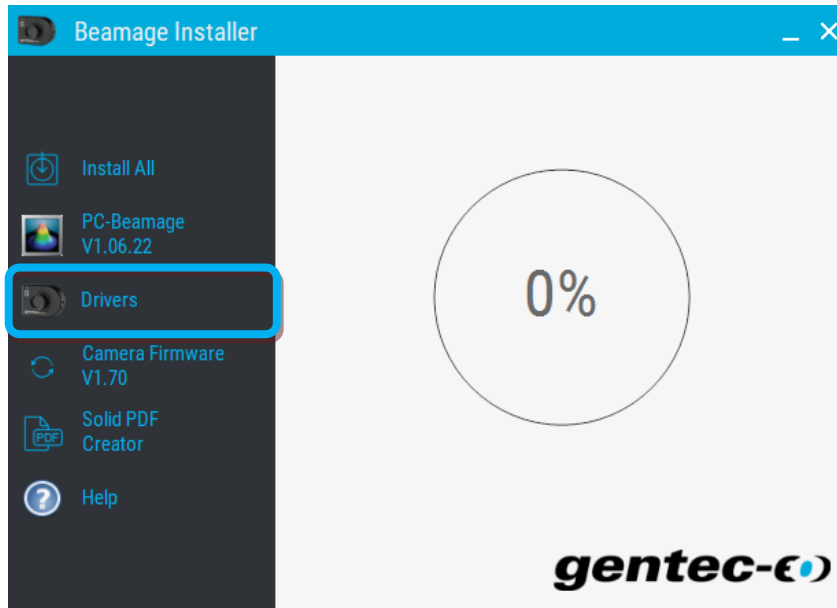

Figure D-2 Beamage Installer (Beamage Drivers)

- 4) Click on the “Drivers” button and wait the driver installation done, see **Figure D-3**

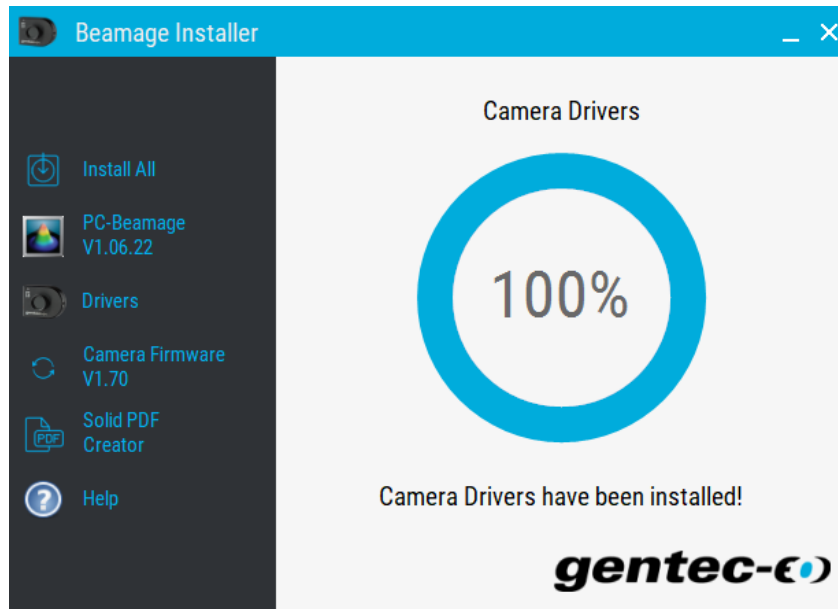

Figure D-3 Camera Drivers

When installing the drivers, it is possible that the installation of Microsoft Visual C++ 2015-2022 Redistributable is required. Beamage Installer will do installation automatically, but if the installer fails to install the missing dll file, an error message will be displayed and the drivers will not be installed, see **Figure D-4**

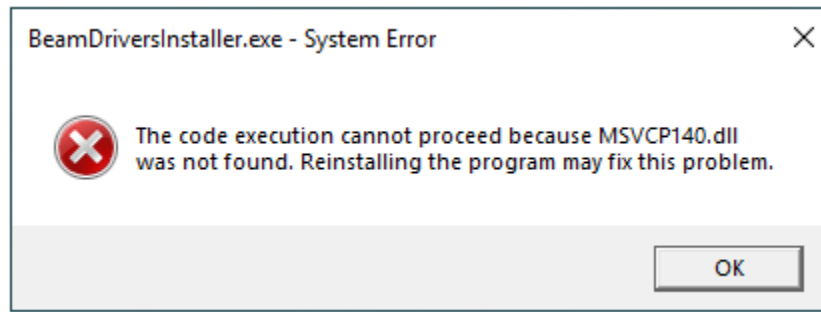

Figure D-4 Missing DLL file Error Message

You can download the missing dll file using the link below:

32 bits: [Microsoft Visual C++ 2015-2022 \(x86\)](#)

64 bits: [Microsoft Visual C++ 2015-2022 \(x64\)](#)

Or by visiting the Microsoft website, Visual Studio 2015, 2017 and 2019 section:

[Support Microsoft](#)

Verify that the driver has been correctly installed

It is not necessary to follow these steps to install the USB drivers. They are verification steps only.

- 1) Open your Device Manager. To open the *Device Manager*, click on the *Start* (Windows home screen) and type in *Device Manager* in the search field. Click on *Device Manager* under *Control Panel*. Be careful not to click on *Devices and Printers* instead of *Device Manager*.

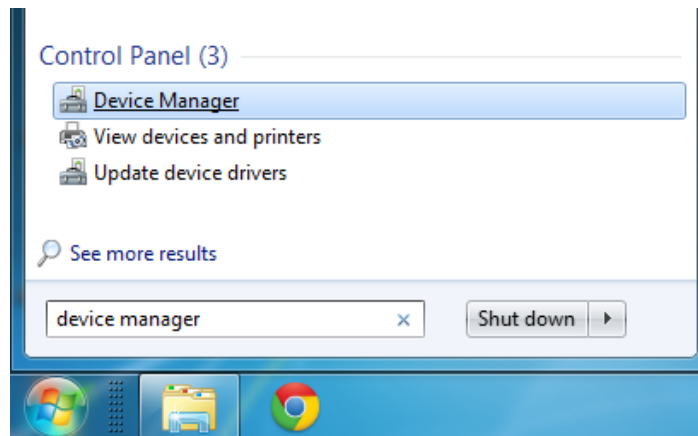

Figure D-5 Search for “Device Manager”

You can also open the Device Manager through the System Window

- 2) Close the PC-Beamage application (if it is already opened). Connect the Beamage camera to your computer. If everything went well until now, the device *Cypress USB BootLoader* should be marked by a yellow warning in the *Device Manager*. It should be located under *Universal Serial Bus controllers*.

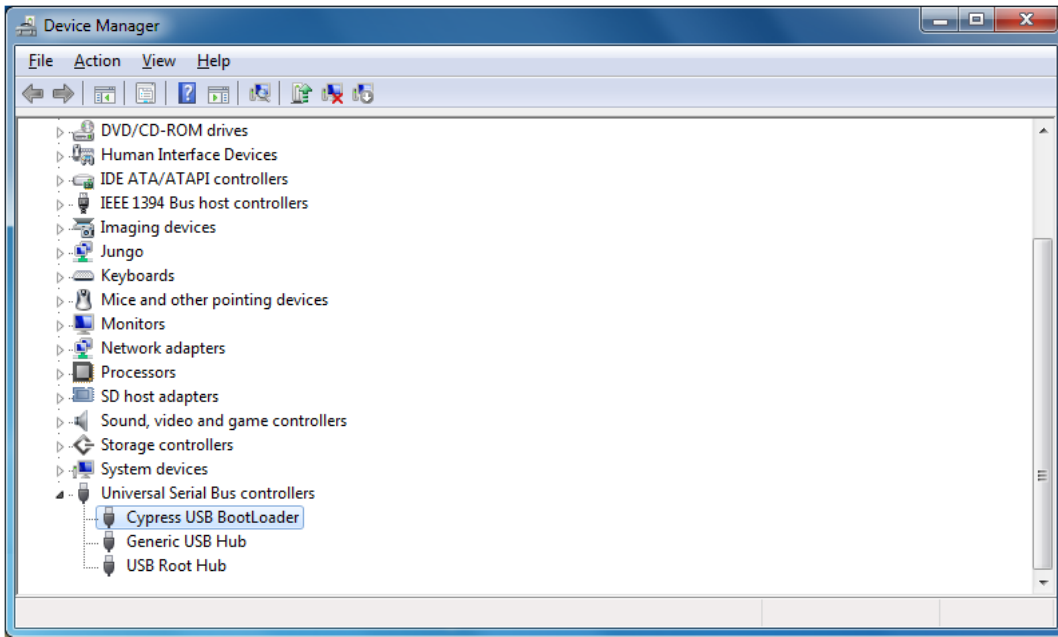

Figure D-6 Cypress USB BootLoader

- 3) Open PC-Beamage and make sure *Cypress USB BootLoader* has been replaced by *Cypress USB BulkloopExample*.

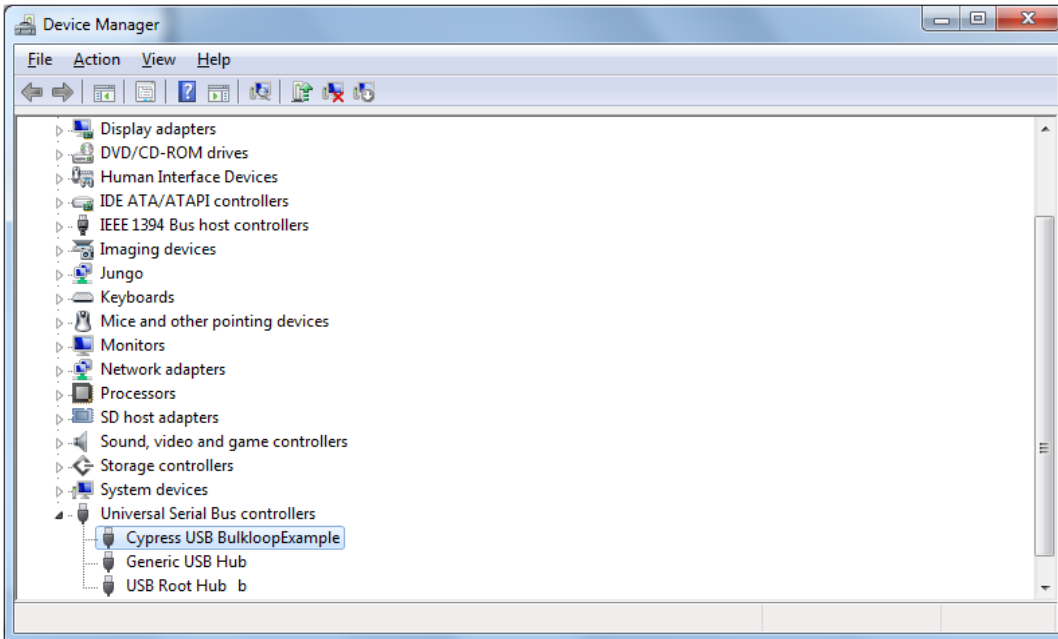

Figure D-7 Cypress USB BulkloopExample

APPENDIX E. BEAMAGE FIRMWARE INSTALLATION QUICK GUIDE

- 1) If the software version of the PC-Beamage is not compatible with the Beamage's firmware version, an error message will appear. **If so, it is important to update the firmware version and to reinstall the drivers in order to use the PC-Beamage's new functions.**
- 2) First, download the latest Beamage Installer available on Gentec-EO's website at <https://www.gentec-eo.com/resources/download-center>
- 3) Connect the Beamage to your computer. If the Beamage is already connected, please disconnect and reconnect it.
- 4) Click on the "Camera Firmware" button, see Figure E-1.

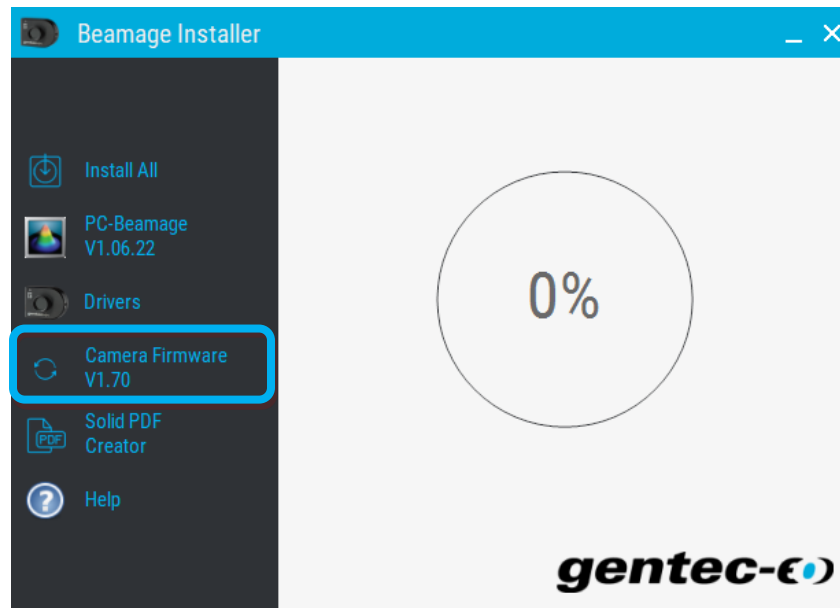

Figure E-1 Camera Firmware Button.

- 5) Click on "Update".

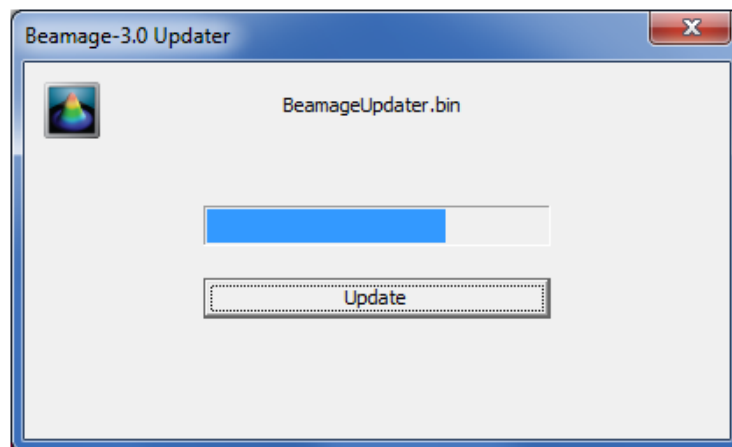

Figure E-2 BeamageUpdater

The Beamage Updater might ask you to reset the Beamage. If so, please disconnect and reconnect the Beamage and click on "Update" again.

- 6) Once this is done, a message box will appear. Click on *OK*.

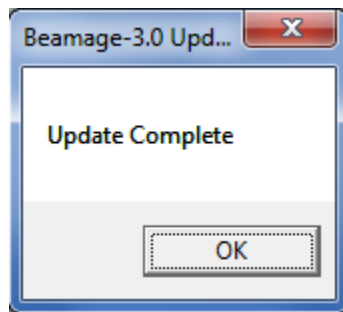

Figure E-3 Update Complete

- 7) Once the firmware is up to date, update the drivers by following the steps described in Appendix B. Please note that even if the drivers were previously installed, the new software and firmware versions need a new driver installation.

APPENDIX F. PC-BEAMAGE UPDATES

- 1) If the new version of PC-Beamage is available, the following message will be displayed when PC-Beamage is started, see Figure F-1

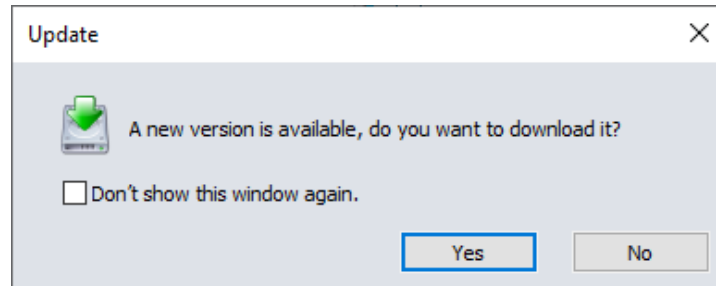

Figure F-1 Update Message

- 2) Click on the "Yes" button to start the download of Beamage Installer. The Beamage Installer contains the new version of PC-Beamage, see Figure F-2

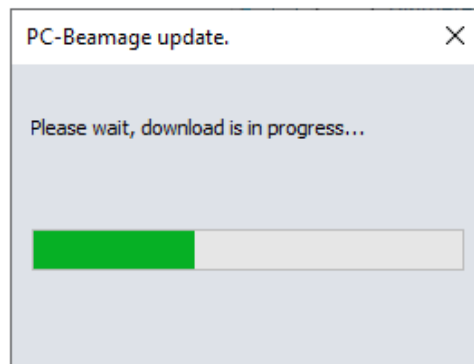

Figure F-2 PC-Beamage Update

- 3) Once the Beamage Installer is downloaded, PC-Beamage will close and the new Beamage Installer will start automatically.
- 4) Click on the "PC-Beamage VX.XX.XX" button to install the new version, see Figure F-3

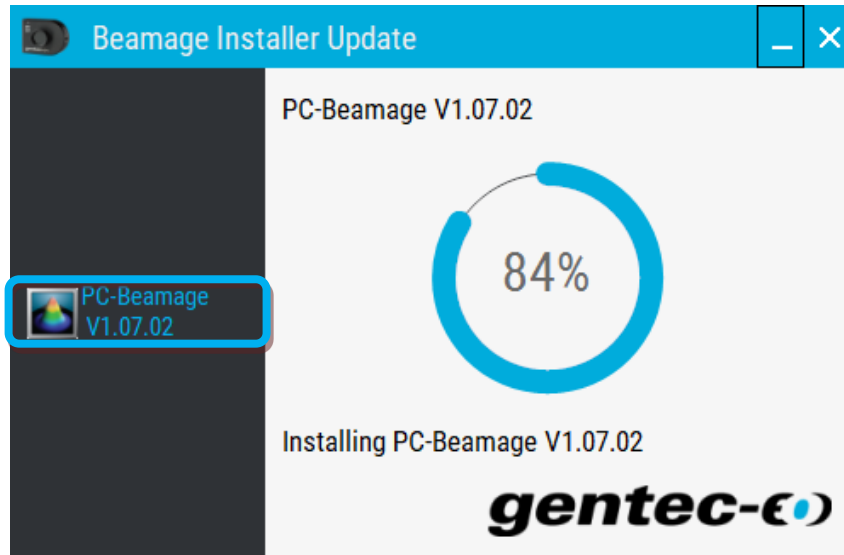

Figure F-3 PC-Beamage Install Button



Tip

To stop being notified about new updates, select the “Don’t show this window again” option and click the “No” button to close the message, see **Figure F-4**

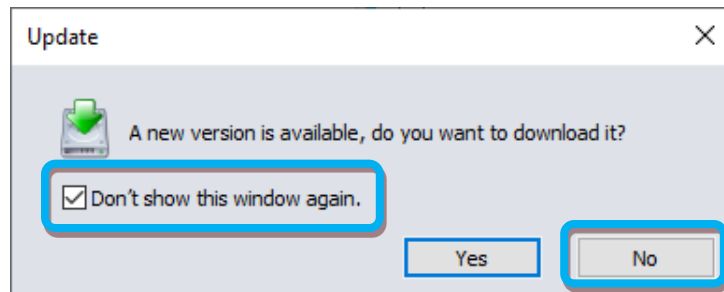

Figure F-4 Don't show this window again option

Checking for a new version of PC-Beamage without an internet connection

If your computer doesn't have an internet connection, a message will be displayed every 6 months after the installation date, this message invites you to visit our website <https://www.gentec-eo.com/fr/ressources/telechargements> and check if there is a new software version of PC-Beamage, see **Figure F-5**

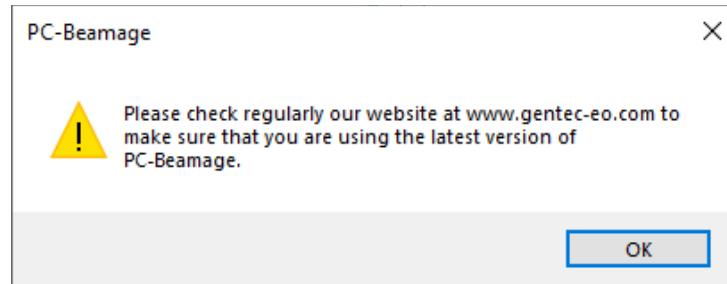

Figure F-5 Check For Updates Message

Check for updates options

In the *Advanced* ribbon tab in the information group, click on the "Help" button and choose the "Check for updates" options to verify if the new version of PC-Beamage is available, see **Figure F-6**

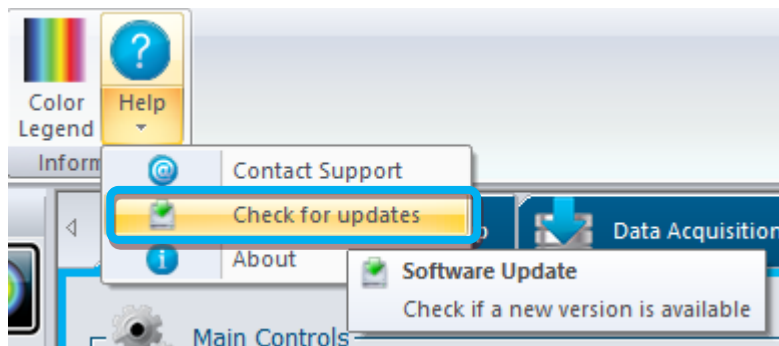

Figure F-6 Check for updates option

If a new version is available, the following message will be displayed, see **Figure F-7**, click on the "Yes" button to start the download of Beamage Installer Update that contains the new version of PC-Beamage.

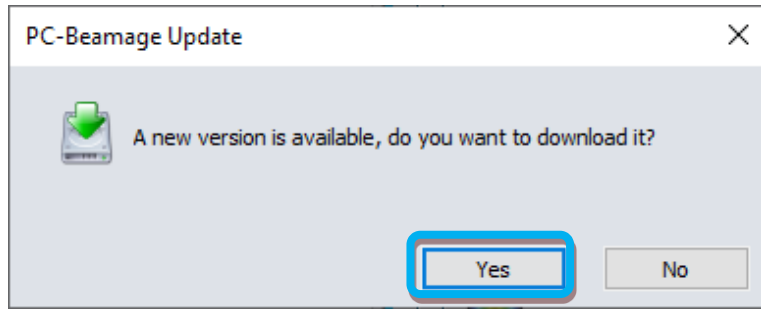

Figure F-7 PC-Beamage Update

If you ready use the latest version, the following message will be displayed, see **Figure F-8**

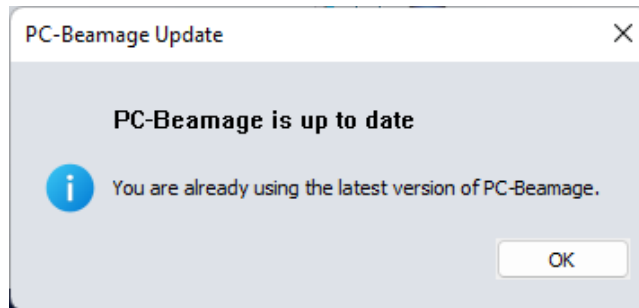

Figure F-8 PC-Beamage is up to date



An internet connection is required to verify if a new version is available, so if you don't have the internet, the following message will be displayed, see **Figure F-9**

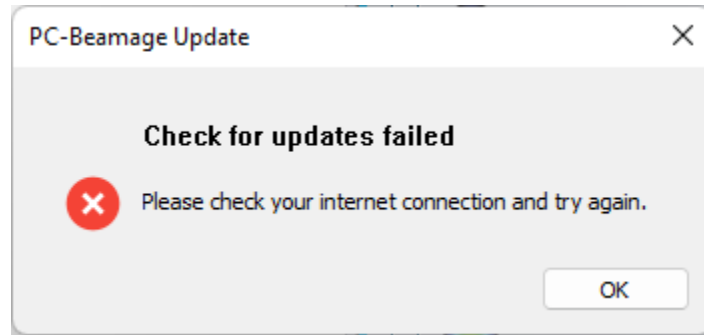

Figure F-9 Check for update failed

Checking for a new version of PC-Beamage without an internet connection

If your computer doesn't have an internet connection, a message will be displayed every 6 months after the installation date, this message invites you to visit our website <https://www.gentec-eo.com/fr/ressources/telechargements> and check if there is a new software version of PC-Beamage, see **Figure F-5**

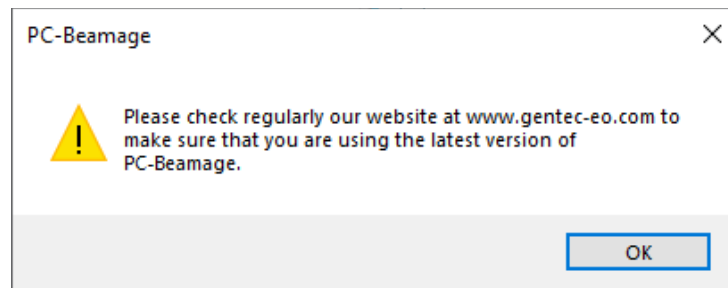

Figure F-10 Check For Updates Message

APPENDIX G. RECYCLING AND SEPARATION PROCEDURE FOR WEEE

This section is used by the recycling center when the Beamage reaches its end of line. Breaking the calibration seal or opening the Beamage's case will void the warranty

The complete Beamage contains:

- 1 Beamage
- 1 USB 3.0 cable with screw locks
- 1 BNC to SMA connector
- 1 Software CD-ROM

SEPARATION

Plastic: Aperture cap, SMA cap.

Metal: Beamage case, screws, SMA connector, BNC to SMA connector, ND filter holder.

Wires: USB cable.

Printed circuit board: inside the Beamage.

Glass: ND filter.

CD: CD-ROM.

DISMANTLING PROCEDURE

Remove the 3 screws on the BEAMAGE's back cover with an Allen key.

Remove the 1 screw holding the PCB's with a flat screw driver.

Cut the wire between the PCB and the SMA connector.

Remove the ND filter and remove the glass with a spanner wrench.

APPENDIX H. COMPLETE LIST OF SAVED SETTINGS

- Image buffer size
- Smoothing filter activated
- Despeckle filter activated
- IR filter activated
- Normalize option activated
- Trigger option activated
- Turbo option activated
- Divergence tab is activated
- Relative position tab is activated
- Camera lens calibration tab is activated
- Fixed crosshair tab is activated
- Crosshair Display options:
 - Gaussian activated
 - Semilog activated
 - Data cursor activated
 - FWHM activated
 - 1/e2 activated
- Measurements tab options:
 - Beam diameter definition
 - Crosshair center choice
 - Crosshair orientation choice
- Setup tab options:
 - Is auto exposure time activated
 - Exposure time
 - Image rotation
 - Image flip vertical
 - Image flip horizontal
 - Image buffer averaging
 - Active area:
 - Choice
 - Left
 - Top
 - Center activated
 - Width
 - Height
 - Pixel addressing mode
 - Camera numerical gain
 - Camera bit depth
 - Magnification factor
- Acquisition tab options:
 - Acquisition mode
 - Duration:
 - Days
 - Hours
 - Minutes
 - Seconds
 - Sample rate images
 - Sample rate:
 - Days
 - Hours
 - Minutes
 - Seconds
 - Acquisition filename
- Divergence tab options:
 - Focal distance
- Relative position tab options:
 - Relative position mode
 - X baseline position
 - Y baseline position
 - Save to log activated
- Camera lens calibration tab options:
 - X baseline position
 - Moving distance in X
 - Is calibrated activated
- Fixed crosshair tab options:
 - Fixed crosshair mode
 - X crosshair baseline position
 - Y crosshair baseline position

Crosshair angle

APPENDIX I. SATURATION LIMIT FOR BEAMAGE WITH ND4.0 FILTER

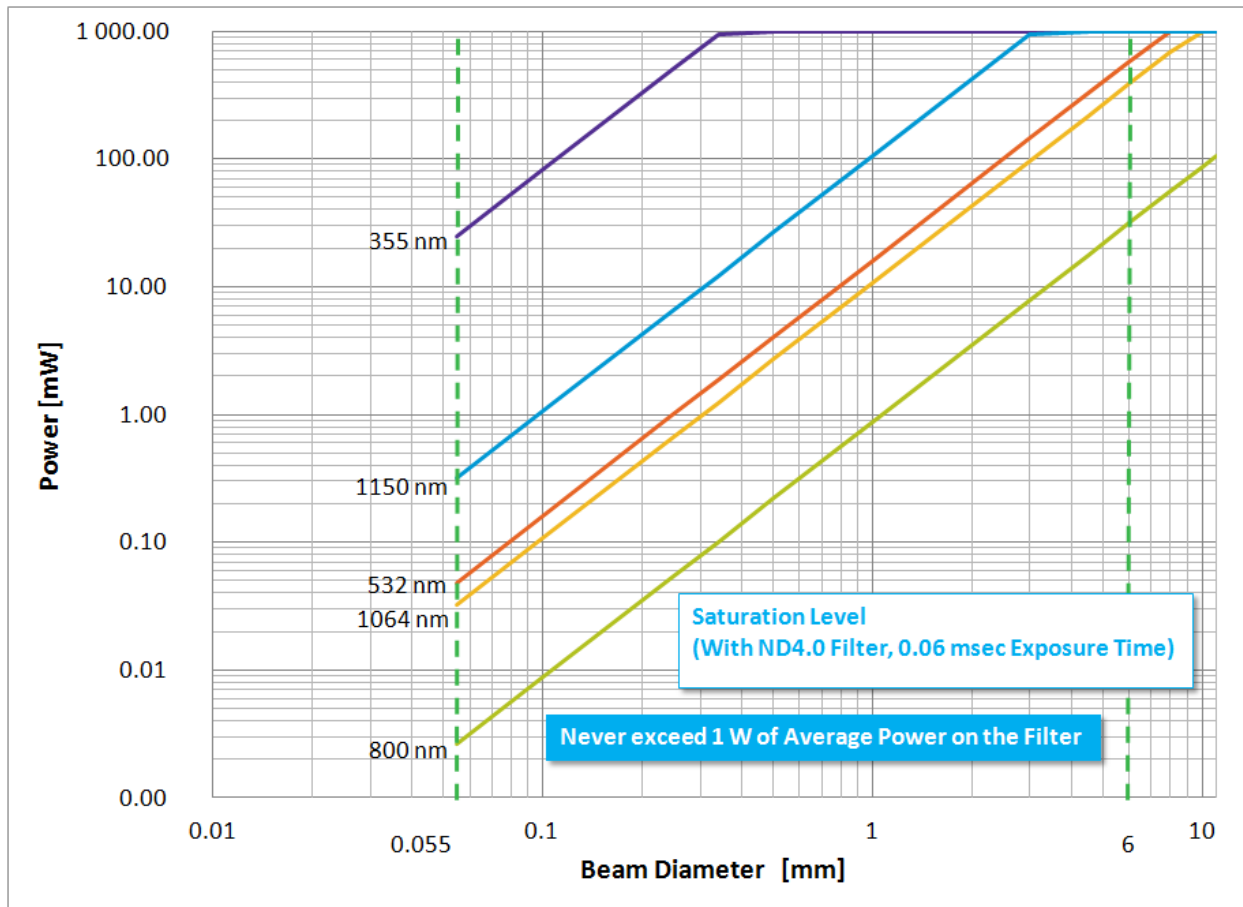

Figure H-1 Saturation Limit for Beamage with ND4.0 Filter and 0.06 msec Exposure Time

LEADER IN LASER BEAM MEASUREMENT SINCE 1972



POWER & ENERGY METERS



BEAM PROFILING



THZ MEASUREMENT

CANADA

445 St-Jean-Baptiste, Suite 160
Quebec, QC, G2E 5N7
CANADA

T (418) 651-8003
F (418) 651-1174

info@gentec-eo.com

UNITED STATES

5825 Jean Road Center
Lake Oswego, OR, 97035
USA

T (503) 697-1870
F (503) 697-0633

info@gentec-eo.com

JAPAN

Office No. 101, EXL111 building,
Takinogawa, Kita-ku, Tokyo
114-0023, JAPAN

T +81-3-5972-1290
F +81-3-5972-1291

info@gentec-eo.com

CALIBRATION CENTERS

- 445 St-Jean-Baptiste, Suite 160
Quebec, QC, G2E 5N7, CANADA
- Werner von Siemens Str. 15
82140 Olching, GERMANY
- Office No. 101, EXL111 building,
Takinogawa, Kita-ku, Tokyo
114-0023, JAPAN