



# USER MANUAL

PRONTO-50 and PRONTO-250 series | Pocket-Size Power Probes

## WARRANTY

All Gentec-EO products carry a one-year warranty from the date of shipment on material or workmanship defects when used under normal operating conditions.

Gentec-EO will repair or replace, at its sole discretion, any product that proves to be defective during the warranty period.

The warranty does not cover damages caused by product misuse, product modifications, accidents, abnormal operating or handling conditions, or third-party battery leakage. Any attempt by an unauthorized person to alter or repair the product voids the warranty. Gentec-EO is not liable for consequential damages of any kind.

## CLAIMS

For warranty service, please contact your Gentec-EO representative or fill out an RMA request:

<https://www.gentec-eo.com/contact-us/support-rma-request>

To help us answer your request more efficiently, please have your product serial number ready before contacting customer support.

Upon receipt of return authorization, ship the product according to the RMA instructions. Do not ship items without a return authorization. Transport is at the customer's expense, in both directions, unless the product has been received damaged or non-functional. Gentec-EO assumes no responsibility for the damage caused in transit.

## SAFETY INFORMATION

Do not use a Gentec-EO device if the monitor or the detector looks damaged or if you suspect that the device is not operating properly.

Refer to the specific instructions for more information. Wait a few minutes before handling the detectors after they are powered up. The surfaces of the detectors get very hot, and there is a risk of injury if they have not cooled.

**Note:** This equipment has been tested and found to comply with the limits for a Class A digital device, pursuant to part 15 of the FCC Rules. These limits are designed to provide reasonable protection against harmful interference in a residential installation. This equipment generates, uses and can radiate radio frequency energy. If not installed and used in accordance with the instructions, it may cause harmful interference to radio communications. However, there is no guarantee that interference will not occur in a particular installation. If this equipment does cause harmful interference to radio or television reception, which can be determined by turning the equipment off and on, try to correct the interference by taking one or more of the following steps:

- Reorient or relocate the receiving antenna.
- Increase the distance between the equipment and receiver.
- Connect the equipment to an outlet that is on a different circuit than the receiver.
- Consult the dealer or an experienced radio/TV technician for help.

**Caution:** Changes or modifications not expressly approved in writing by Gentec-EO Inc. may void the user's authority to operate this equipment.

## SYMBOLS

The following international symbols are used in this manual:



Refer to the manual for specific warning or caution information to avoid any damage to the product.

## Table of contents

1.	PRONTO-50 and PRONTO-250 series portable laser probes .....	6
1.1.	Included with your PRONTO .....	6
1.2.	Introduction.....	6
1.3.	Warnings and disclaimer.....	7
1.4.	Specifications .....	8
1.5.	Minimum beam diameter (damage threshold).....	10
1.6.	Mechanical description.....	12
2.	Operating instructions.....	13
2.1.	User interface .....	13
2.2.	Turning the device on and off.....	13
2.3.	Changing the settings .....	14
2.3.1.	Opening and closing the settings menu.....	14
2.3.2.	Settings icons.....	14
2.3.3.	Changing the orientation of the screen .....	14
2.3.4.	Changing the brightness of the screen .....	14
2.3.5.	Adjusting the correction factor .....	15
2.3.6.	Getting information about the device .....	15
2.4.	Changing the wavelength.....	16
2.5.	Making a measurement (SSP mode only) .....	17
2.6.	Acquiring, transferring and deleting data .....	18
2.6.1.	Acquiring data .....	18
2.6.2.	Transferring data.....	18
2.6.3.	Deleting data.....	18
3.	Operating instructions (PRONTO-250-FLEX and PRONTO-250-EZ only).....	19
3.1.	Zeroing (CWP mode only) .....	19
3.2.	Setting the scale (CWP and SSE modes only).....	19
3.3.	Setting the trigger level (SSE mode only) .....	20
3.4.	Making a measurement.....	21
3.4.1.	SSP mode.....	21
3.4.2.	CWP mode.....	21
3.4.3.	SSE mode.....	21
4.	Safety instructions .....	22
4.1	General.....	22
4.2	Damage to the optical absorber material.....	22
4.3	Not exceeding the maximum sensor temperature .....	22

---

4.4	How to properly handle the device .....	23
5.	USB communication.....	24
5.1.	Description .....	24
5.2.	Setting up communication to the PRONTO .....	24
5.2.1.	Connect the monitor .....	24
5.2.2.	To echo commands .....	24
5.2.3.	Test the connection .....	24
5.3.	Serial command format.....	25
5.3.1.	Serial protocol rules .....	25
5.3.2.	Text mode rules .....	25
5.4.	List of serial commands for the PRONTO (summary).....	26
5.5.	Detailed description of the serial commands for PRONTO (complete) .....	27
5.5.1.	Display .....	27
5.5.2.	Data acquisition .....	31
5.5.3.	Setup.....	33
5.5.4.	Control .....	34
5.5.5.	Instrument and detector information .....	39
5.5.6.	Error messages.....	43
6.	USB driver installation .....	44
7.	Maintenance .....	44
7.1.	Free firmware upgrade .....	44
7.2.	Pronto-250 EZ absorber cleaning.....	44
8.	Declaration of conformity .....	45
9.	UKCA declaration of conformity.....	46
10.	Appendix A – WEEE Directive .....	47
11.	Appendix B – installing the ProntoDataTransfer software .....	48
12.	Appendix C – Updating the PRONTO firmware.....	51

## 1. PRONTO-50 AND PRONTO-250 SERIES PORTABLE LASER PROBES

### 1.1. INCLUDED WITH YOUR PRONTO

The following items are included with the PRONTO.

Description	Part name	Part number
PRONTO laser power monitor		
USB-A to USB-mini 1.8 m cable	MAE-USB	202372
Carrying case		104774
Calibration certificate		

### 1.2. INTRODUCTION

The PRONTO Portable Laser Probes from Gentec-EO are pocket-size power and energy meters with built-in display. The PRONTO-50-W5, PRONTO-250-FLEX and PRONTO-250-EZ give accurate measurement of laser power up to 50 W and 250 W in only 5 seconds. In addition to the regular single-shot power (SSP) mode, the PRONTO-250-FLEX and PRONTO-250-EZ features two additional measurement modes: in continuous power (CWP) mode, the device measures power continuously up to 8 W while in single-shot energy mode (SSE), it measures the energy of individual pulses. The high-power surface absorber sensors are designed to be used at high average power densities.

If the desired wavelength is outside the calibrated spectral range, you can use the “Correction Factor” function to adjust the displayed measurements.

Call your nearest Gentec-EO distributor to repair or to recalibrate the PRONTO. To find the nearest Gentec-EO office or distributor in your country, refer to the contact section on our website at [www.gentec-eo.com/contact-us](http://www.gentec-eo.com/contact-us).

#### Legacy models

PRONTO-250, PRONTO-250-CO2 and PRONTO-250-PLUS have been replaced by the PRONTO-250-FLEX and PRONTO-250-EZ models. The new model offers calibration options that can correspond to the legacy PRONTO-250 or PRONTO-250-PLUS.

	PRONTO-250	PRONTO-250-PLUS
Calibrated spectral range	0.248 - 2.5 $\mu\text{m}$ and 10.6 $\mu\text{m}$	0.248 - 2.5 $\mu\text{m}$ and 10.6 $\mu\text{m}$
Calibration uncertainty in SSE mode	Not available	$\pm 5\%$
Measurement modes	SSP only	SSP, CWP and SSE
Equivalent PRONTO-250-FLEX	Options Y and C	All three calibrations: Y, C and E

### 1.3. WARNINGS AND DISCLAIMER

Laser power detection is completely automatic. There is no need for an external timer.



#### Warnings

WHEN **HOT** APPEARS ON THE SCREEN, REMOVE THE DEVICE FROM THE BEAM IMMEDIATELY TO AVOID DAMAGING THE SENSOR.

Be careful not to exceed the maximum levels and densities stated in the specifications.

The handle on the PRONTO is for carrying purposes only. The user must not hold the PRONTO during measurements. Extreme caution must be taken during laser power measurements.

In no event shall Gentec-EO or any of its affiliates be liable for any indirect, special, incidental or consequential injury to persons or damage to property caused by the use of any of our products. By purchasing from Gentec-EO or any of its affiliates, you hereby indicate that you understand and agree to the following:



#### Disclaimer

I am fully responsible for the safe application and use of this detector and agree to such by completing the sales process.

I will not use a laser device without wearing approved laser safety goggles designed for such a purpose.

I am aware and responsible for safely dealing with any back reflections. I will not use the detector in violation of any local, state or federal law, and I understand that it is my responsibility to know and abide by those laws relating to the ownership and use of the detector in my jurisdiction.

### 1.4. SPECIFICATIONS

These products all have an NIST-traceable calibration at 1064 nm, and they also have a traceable wavelength correction to complete the calibrated spectral range. The PRONTO-250-FLEX / EZ can be purchased with an additional calibration at 10.6 μm (calibration option C). The PRONTO-250-FLEX / EZ can also have an additional calibration for SSE mode (calibration option E).

The following specifications are based on a one-year calibration cycle, an operating temperature of 15 °C to 28 °C (59 °F to 82 °F) and a relative humidity not exceeding 80%. Monitors must be stored in an environment between 10 °C to 60 °C (50 °F to 140 °F) and a relative humidity not exceeding 90%.

	PRONTO-250-FLEX	PRONTO-250-EZ	PRONTO-50-W5
	<b>Sensor and calibration</b>		
Aperture	19 mm Ø		
Spectral range	0.19 - 20 μm		0.19 - 10 μm
Calibrated spectral range <sup>1</sup>	Default option Y: 0.248 - 2.5 μm Option C: 10.6 μm		0.248 - 2.5 μm
Programmed spectral range <sup>2</sup>	0.193 - 10.6 μm		0.193 - 2.5 μm
Power range (in SSP mode)	0.5 - 250 W		0.5 - 50 W
Noise level	10 mW		4 mW
Response time (in SSP mode)	5 s		
Calibration uncertainty	± 3 %		
	<b>CWP mode</b>		
Power range in CWP mode	0.01 - 8 W		Not available
Noise level in CWP mode <sup>3</sup>	10 mW		
Typical rise time in CWP mode (0% - 5%)	1.5 s		
Maximum device temperature at maximum power (in CWP mode)	55 °C		
Calibration uncertainty in CWP mode	± 2.5%		
	<b>SSE mode</b>		
Energy range in SSE mode (> 1 ns)	0.06 - 25 J up to 150 J for pulse >1 ms		Not available
Noise level in SSE mode	60 mJ		
Trigger level	0.1%-99.9% (default level is 2%)		
Minimum repetition period	4 s		

<sup>1</sup> Standard units are calibrated at one wavelength (1064 nm) and have a NIST-traceable wavelength correction factor to cover the complete calibrated spectral range. This corresponds to PRONTO-250-FLEX / EZ calibration option Y.

**As an option, PRONTO-250-FLEX / EZ can also include calibration option C (calibration at 10.6 μm) or calibration option E (calibrated for SSE measurements)**

<sup>2</sup> Available wavelengths in the user interface. Typical values are used outside the calibrated spectral range.

<sup>3</sup> Excluding possible offset and used with an opto-mechanical stand.



	PRONTO-250-FLEX	PRONTO-250-EZ	PRONTO-50-W5
Maximum pulse width	88 ms		
Typical rise time in SSE mode (0%-100%)	0.26 s		
Calibration uncertainty in SSE mode <sup>1</sup>	Option E: ± 5%		
<b>Damage thresholds and laser limits</b>			
Maximum average power density  1064 nm, 10 W, CW 10.6 μm, 10 W, CW	45 kW/cm <sup>2</sup> 14 kW/cm <sup>2</sup>	65 kW/cm <sup>2</sup> NA	100 kW/cm <sup>2</sup>
Maximum number of readings and exposure time before probe must be cooled (for 25 °C starting temperature, see Section 4.3 for more information)	<u>Power</u>	<u>Max # readings / Max exposure time</u>	
	8 W	∞ / ∞	∞ / ∞
	25 W	10 / 60 sec	10 / 60 sec
	50 W	5 / 30 sec	5 / 30 sec
	125 W	2 / 12 sec	N/A
	250 W	1 / 6 sec	N/A
Maximum device temperature at maximum power	65 °C		
Pulsed laser damage thresholds: maximum energy density 1064 nm, 360 μs, 5 Hz 1064 nm, 7 ns, 10 Hz 532 nm, 7 ns, 10 Hz 266 nm, 7 ns, 10 Hz	9 J/cm <sup>2</sup> 1.0 J/cm <sup>2</sup> 0.6 J/cm <sup>2</sup> 0.3 J/cm <sup>2</sup>	13 J/cm <sup>2</sup> 1.5 J/cm <sup>2</sup> 0.6 J/cm <sup>2</sup> N/A	100 J/cm <sup>2</sup> 1.1 J/cm <sup>2</sup> 1.1 J/cm <sup>2</sup> 0.7 J/cm <sup>2</sup>
<b>Damage thresholds and laser limits</b>			
Pulsed laser damage thresholds: peak power density 1064 nm, 360 μs, 5 Hz 1064 nm, 7 ns, 10 Hz 532 nm, 7 ns, 10 Hz 266 nm, 7 ns, 10 Hz	25 kW/cm <sup>2</sup> 143 MW/cm <sup>2</sup> 86 MW/cm <sup>2</sup> 43 MW/cm <sup>2</sup>	25 kW/cm <sup>2</sup> 143 MW/cm <sup>2</sup> 86 MW/cm <sup>2</sup> NA	667 kW/cm <sup>2</sup> 157 MW/cm <sup>2</sup> 157 MW/cm <sup>2</sup> 27 MW/cm <sup>2</sup>
Minimum frequency for pulsed lasers	15 Hz		
<b>Physical characteristics</b>			
Dimensions	59 W x 181 L x 17 D mm		
Weight	210 g		
Mounting holes (for post)	2 x 8-32		
Operating conditions	Ambient temperature: 15 °C to 28 °C Maximum relative humidity: 80%		
Storage conditions	Ambient temperature: 10 °C to 60 °C Maximum relative humidity: 90%		

<sup>1</sup> If SSE calibration is not purchased, a typical calibration value will be included in the PRONTO-250-FLEX.

	PRONTO-250-FLEX	PRONTO-250-EZ	PRONTO-50-W5
Battery type	USB rechargeable Li-ion		
Battery life	17 hours or 4200 measurements (with brightness set at 25%) Charge time: 7.5 hours when totally empty		
Maximum battery cycle count (amount of charge cycles before the battery loses its efficiency)	Approximately 500 full charges (0%-100%)		
Lithium battery transport compliance	UN: recommendations on the transport of dangerous goods in the Manual of Tests and Criteria, ST/SG/AC.10/11/Rev.6/Amend.1 Section 38.3 <sup>1</sup>		
<b>User interface</b>			
Interface	Touch screen		
Display	Color LCD 28 X 35 mm (128 x 160 pixels)		
Data acquisition and transfer	Maximum of 50 000 measurements Acquisition frequency of 6.8 Hz in CWP mode		
Screen personalization	Four screen orientations and four brightness levels		
Saved settings	Screen orientation, screen brightness, wavelength and correction factor		
Display numerical resolution	Four digits		

### 1.5. MINIMUM BEAM DIAMETER (DAMAGE THRESHOLD)

The following graphic shows the diameter corresponding to the damage threshold for a Gaussian beam profile. The “minimum 1/e<sup>2</sup> beam diameter” is calculated to obtain a peak intensity 50% lower than the damage threshold and should be considered as the “safe” minimum diameter.

<sup>1</sup> UN38.3 certificate available upon request.

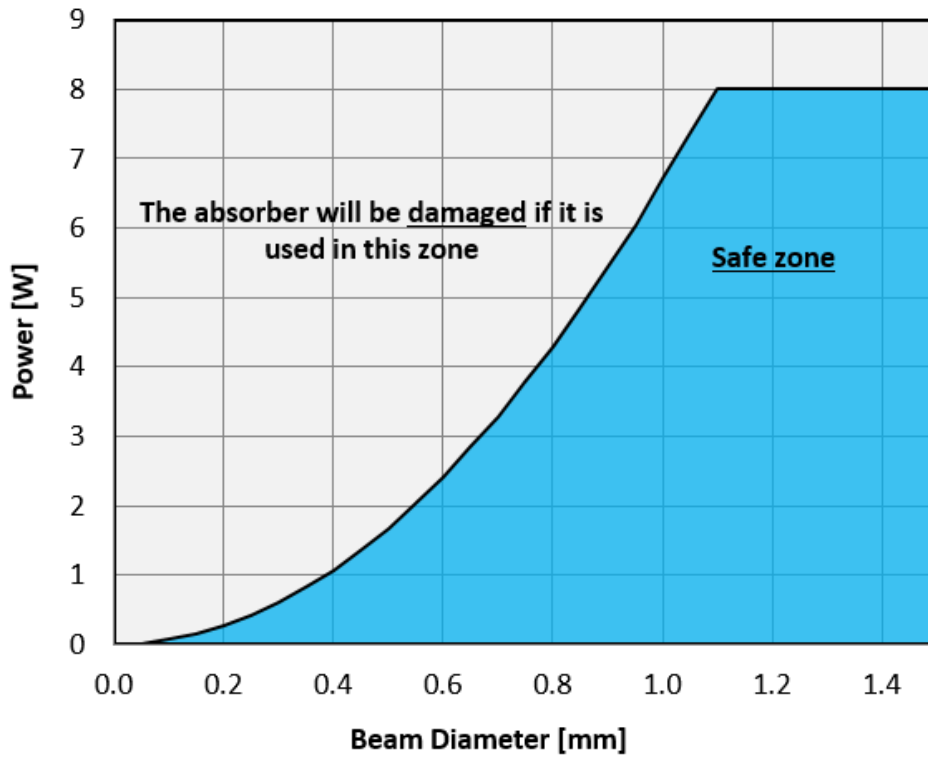

Figure 1. Minimum beam size for a PRONTO-250-FLEX / EZ absorber at 1064 nm in CWP mode

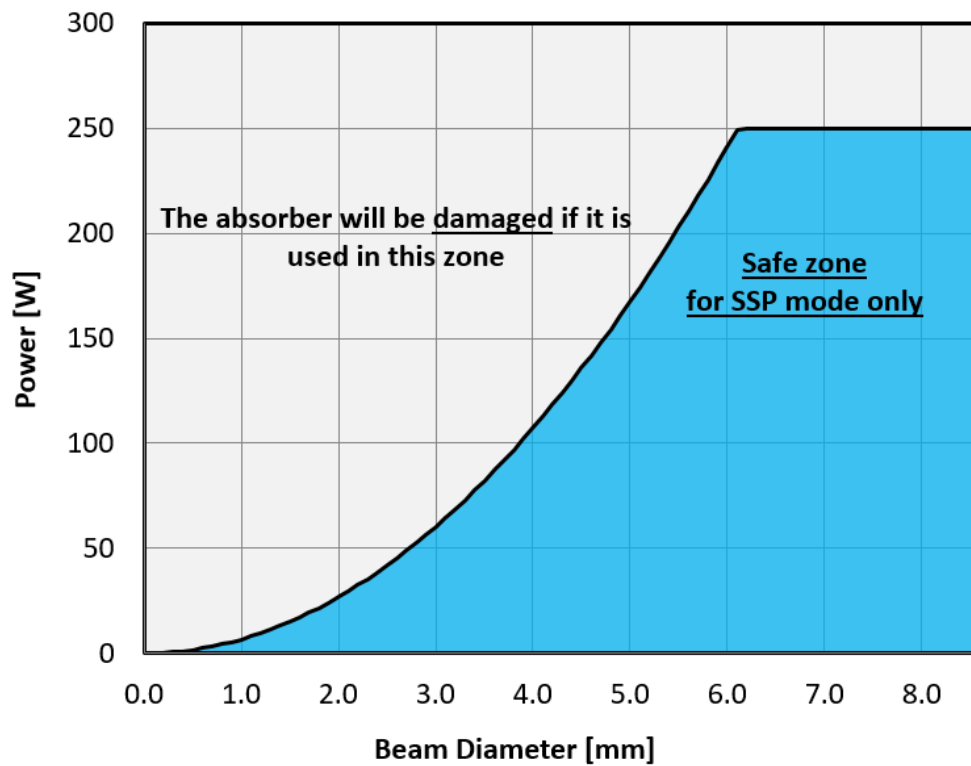

Figure 2. Minimum beam size for a PRONTO-250-FLEX / EZ absorber at 1064 nm in SSP mode

## 1.6. MECHANICAL DESCRIPTION

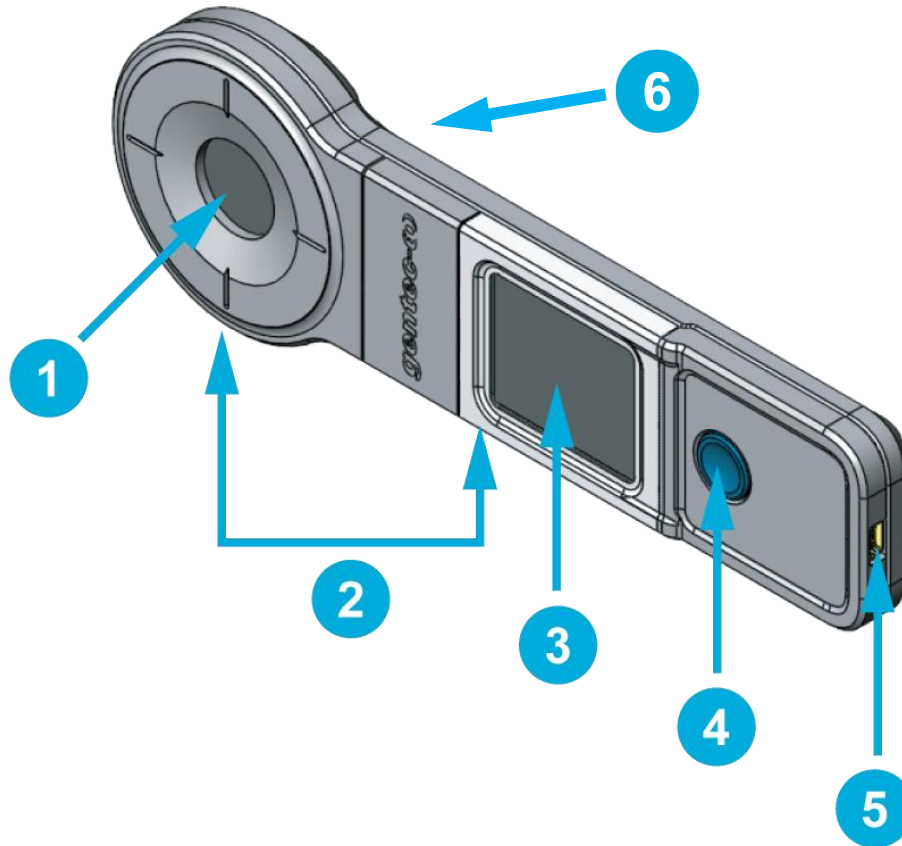

Figure 3. PRONTO mechanics

- 1 Absorber**  
The laser must be centered on the absorber when making a measurement.
- 2 Mounting holes**  
There are two 8-32 mounting holes to fit the device on a post for a safe use during the measurements.
- 3 Touch screen display and controls**  
The touch screen interface controls the device.
- 4 On/off/settings button**  
This button is used to power the device on (press when the device is off) and off (press and hold for 3 seconds when the device is on). It is also used to access the settings menu (press when the device is on).
- 5 USB port**  
The Mini-B USB2.0 port is used to transfer data from the device to a PC and to charge the battery.
- 6 Overheating indicator**  
The central part of the yellow sticker on the rear face turns to black when the temperature of the device exceeds 65 °C (150 °F). This indicates that the detector was probably damaged due to overheating. In this case, contact your local Gentec-EO representative.

## 2. OPERATING INSTRUCTIONS

### 2.1. USER INTERFACE

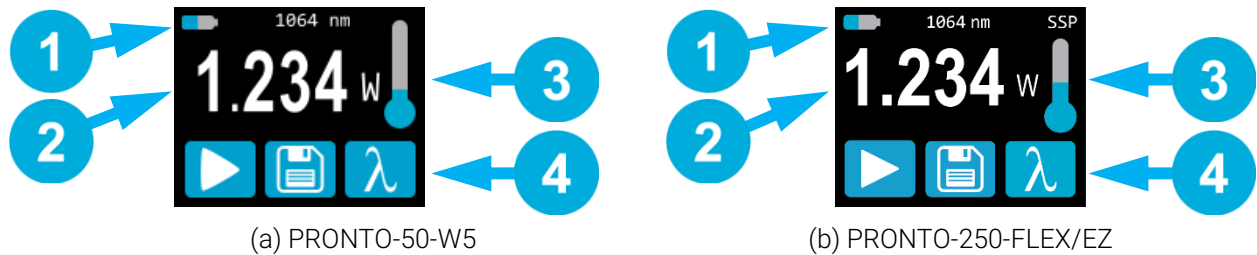



Figure 4. User interface

- 1 Device state**  
The top portion of the display shows the battery level and the selected wavelength. For the PRONTO-250-FLEX / EZ, the top portion also indicates the measurement mode. Its default mode is SSP, which works like the PRONTO-50-W5.
- 2 Measured value**  
The central part of the display shows the last measured value. For the PRONTO-250-FLEX / EZ, this section also serves as a button to access the scales menu in CWP and SSE modes.
- 3 Temperature**  
The thermometer icon shows the head temperature.  
 If the thermometer is red and the screen displays **HOT**, block the laser IMMEDIATELY and let the instrument cool down.
- 4 Controls**  
The first button at the bottom of the display is specific to the measurement mode. The second button (save) is for data acquisition, and the third button (wavelength) opens the wavelength menu.

### 2.2. TURNING THE DEVICE ON AND OFF

Turn on: Press the on/off/settings button 

Turn off: Press and hold the on/off/settings button  for 3 seconds



**Tip**

The device will automatically turn off after 5 minutes of inactivity, except if data is being acquired. When the device is plugged into a PC via the USB cable, it will power on and stay on until it is manually turned off or unplugged.





## 2.3. CHANGING THE SETTINGS

### 2.3.1. Opening and closing the settings menu

When the device is on, short-press the on/off/settings button to access the menu. Pressing the button again will turn it off and save whatever settings have been changed.

### 2.3.2. Settings icons

The following icons are presented in the settings menu. The measurement mode options are only available with the PRONTO-250-FLEX / EZ, since PRONTO-50-W5 always works in single-shot power mode.

Icon	Name	Description
	Screen orientation	Indicates the screen orientation (four options) Press → toggles to the next orientation
	Brightness	Indicates the screen's brightness level (four options) Press → toggles to the next brightness level
	Correction factor	Press → opens the correction factor (user calibration) menu
	About	Press → opens the about menu
<b>For the PRONTO-250-FLEX / EZ only</b>		
	More	Press → switches to the secondary menu
	Single-shot power	Press → goes to single-shot power mode
	Continuous power	Press → goes to continuous power mode
	Single-shot energy	Press → goes to single-shot energy mode

### 2.3.3. Changing the orientation of the screen

There are four possible screen orientations: up, down, left and right. The button displays the current orientation, for example, up: . To change the orientation, simply press the button, and the next choice will appear. The changes will be saved once you exit the settings menu.

### 2.3.4. Changing the brightness of the screen

There are four possible brightness levels: 100%, 75%, 50% and 25%. The button displays the current brightness, for example, 75% . To change the brightness, simply press the button, and the next choice will appear. The changes will be saved once you exit the settings menu.

### 2.3.5. Adjusting the correction factor

It is possible to adjust the calibration of the device. You can do so by applying a correction factor to the measurements. To access the correction factor menu, simply press the CAL button . The number displayed is the multiplication factor that will be applied to the measurements. A factor of 1.000 keeps the calibration unchanged. You can enter any number between 0.500 and 2.500.

The four digits of the correction factor are changed individually. For example, if the correction factor is 1.000 and you want to change it to 1.200, just press the first 0 (make sure it turns blue, like this ) and then increment it twice with the up button.

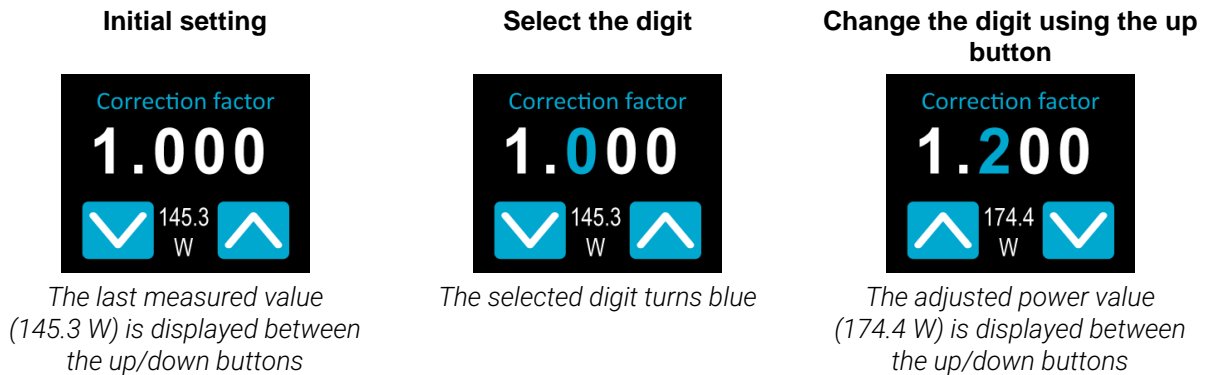

Once the value is entered, press the on/off/settings button to exit the menu and automatically save your new settings.

### 2.3.6. Getting information about the device

Relevant information about the device is stored in the about menu . This information can be useful when returning the device for repairs or recalibration. These include the model name, the serial number, the firmware version and the last calibration date.

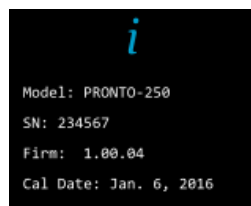

Figure 5. The about menu shows information about the device

Press the on/off/settings button to exit the menu and go back to the measurement screen.

## 2.4. CHANGING THE WAVELENGTH







Before making a measurement, it is important that you adjust the calibration of the device to the wavelength of the source to be measured. To do so, press the wavelength button  to display a list of pre-sets.



Figure 6. The six wavelength buttons can be customized by the user

There are six pre-sets in the wavelength menu. The values can be set to any wavelength defined by the programmed spectral range. To change a value, press it until the screen changes to the set wavelength menu. Each digit is changed individually by selecting it and pressing the up/down arrows. For example, if you want to change 10.6  $\mu\text{m}$  to 532 nm, you need to do the following:

1. Select the units. Make sure they turn blue  and use the up or down button to change them to nm.
2. Select the first number. Make sure it turns blue  and use the down button to reduce it to 0.
3. Select the second number. Make sure it turns blue  and use the up button to increase it to 5.
4. Select the third number. Make sure it turns blue  and use the down button to reduce it to 3.
5. Select the fourth number. Make sure it turns blue  and use the down button to reduce it to 2.
6. You're done! 

Once the desired value is entered, press the on/off/settings button to exit the menu and automatically save your new settings.



## 2.5. MAKING A MEASUREMENT (SSP MODE ONLY)

Once all the settings are adjusted, you are ready to make a measurement. Just follow the step-by-step instructions below.



Tip

We recommend placing the device on an optical stand or on a horizontal surface when making a measurement. Be careful to conform to all the recommended specifications for beam size, placement and laser power.

1. Turn the device on.

2. Press the play  button, a sequence of dots will appear. This indicates that the device is waiting for a laser beam to trigger the measurement.



**Note:** At any time during the measurement sequence, you can press the stop  button. The device will stop the measurement process and go back to its initial state (displaying the last measured value).

3. Place the device in the laser beam path with the laser beam centered on the absorber.
4. As soon as the device detects a laser beam, it will automatically start the 5-second countdown for the measurement. Leave the device in the beam path for the entire countdown period, which will be indicated on the screen.

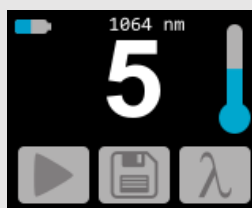

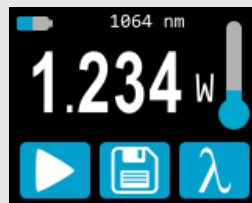

5. Once the countdown is finished, the measurement will appear. You can remove the device from the beam path.



6. The reading will stay on the display until the next measurement, even if you turn the device off and on again.
7. To make a new measurement, go back to step 2.

## 2.6. ACQUIRING, TRANSFERRING AND DELETING DATA

### 2.6.1. Acquiring data

You can store the measurements done by the device simply by pressing the save button . When pressed, the button turns white  to indicate that data is being stored in the internal memory of the device. Once activated, the data acquisition will stay active until stopped. To stop the data acquisition, press the save button again, and it will revert to its original state .

### 2.6.2. Transferring data

To retrieve the data, you must connect the PRONTO to your computer with a USB cable and use the ProntoDataTransfer software . You can download our latest version of the software in the downloads section of our website (<https://gentec-eo.com/downloads>). The data will be uploaded on your computer in a text format, which you can save to a known location on your computer and then open in your preferred analysis software.



#### Warning

Once data has been transferred to a computer, it is deleted from the internal memory of the device.

Complete installation and data transfer instructions can be found in Appendix B – installing the ProntoDataTransfer software.

### 2.6.3. Deleting data

To delete data from the internal memory, you must hold the save button  approximately 3 seconds. A text will appear and ask Erase all data. Hit the yes button then click ok.

### 3. OPERATING INSTRUCTIONS (PRONTO-250-FLEX AND PRONTO-250-EZ ONLY)

#### 3.1. ZEROING (CWP MODE ONLY)

1. Block off any laser radiation to the detector.
2. To set the zero, wait until the reading has stabilized. The power read by the device may not be exactly zero, even in the absence of a laser beam incident on the sensor, if the device is not thermally stable. Wait until the reading without laser power is stable for several minutes. Half an hour warm-up is recommended for measuring low powers precisely.
3. Press the ZERO button . While the device is busy, the control buttons are inactive.

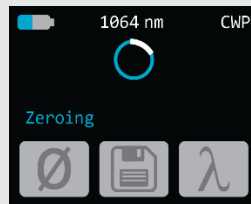

4. When the process is complete, the device returns to the measurement screen, and you are now ready to make an accurate measurement.

When the offset is applied to the measurement, the zero button is white . The offset stays active until the zero button is pressed again or until the PRONTO is turned off.

#### 3.2. SETTING THE SCALE (CWP AND SSE MODES ONLY)

To access the range menu, you must press on the measured value (the central part of the touch screen) for approximately 3 seconds. The up/down arrows scroll through the available ranges and auto, which is the default automatic range setting.



Figure 7. Up and down buttons to set the manual range or to go back to the default auto range setting

Once the desired value is entered, press the on/off/settings button to exit the menu and automatically save your new settings.

### 3.3. SETTING THE TRIGGER LEVEL (SSE MODE ONLY)

In SSE mode, it is possible to control the trigger level. To access the trigger level menu, simply press the trigger level button **TRIG** at the bottom of the measurement screen. Accepted values are between 0.1% and 99.9%. The default value is 2.0%.

The three digits of the trigger level are changed individually. For example, if the trigger level is 2.0% and you want to change it to 5.0%, just press the 2 (make sure it turns blue) and then increment it three times with the up button.



The default value is 2.0%



The selected digit turns blue

Change the digit using the arrows

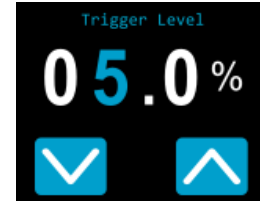

The adjusted level is saved automatically when exiting this screen

Once the desired value is entered, press the on/off/settings button to exit the menu and automatically save your new settings.

### 3.4. MAKING A MEASUREMENT

Once all the settings are adjusted and the desired measurement mode is selected, you are ready to make a measurement. Just follow the step-by-step instructions below.



#### Tip

We recommend placing the device on an optical stand or on a horizontal surface when making a measurement.

Be careful to conform to all the recommended specifications for beam size, placement and laser power.

#### 3.4.1. SSP mode

Instructions for this mode are detailed in Section 2.5.

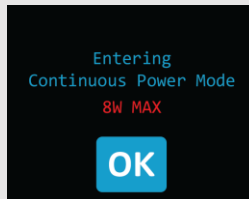

#### 3.4.2. CWP mode

1. Turn the device on.
2. The PRONTO displays a warning (8 W maximum), press OK.



3. For maximum accuracy, adjust the reading to zero before making measurements (see Section 3.1). For low power measurements, the sensor must be protected from ambient light and temperature fluctuations.
4. Place the device in the laser beam path with the laser beam centered on the absorber.
5. The device will automatically display and update the power value.

#### 3.4.3. SSE mode

1. Turn the device on.
2. Place the device in the laser beam path with the laser beam centered on the absorber.
3. As soon as the device detects a laser pulse, it will automatically measure its energy.
4. The trigger level button  turns gray  every time a pulse is detected.
5. For accurate results, do not touch the screen while taking measurements and conform to the specifications for the laser pulse width and the repetition rate.

## 4. SAFETY INSTRUCTIONS

### 4.1 GENERAL

To ensure a long lifetime of accurate measurements, the PRONTO power probe should be maintained within the following ambient conditions:

- Storage environment temperature: 10 °C to 60 °C, RH < 90%
- Operating environment temperature: 15 °C to 28 °C, RH < 80%

It is possible to store and operate your PRONTO power probe beyond this range. For any specific requirements, please contact your local Gentec-EO representative.

For the most accurate measurements, center the beam on the sensor. Ideally, the beam diameter should be the same as the one used during calibration. The beam diameter at calibration corresponds to > 98% of the encircled power centered on 50% of the sensor's surface area. This complies with the International Electrotechnical Commission standard #1040: "Power and energy measuring detector [...]". Refer to the calibration certificate for the exact beam diameter used during calibration.

### 4.2 DAMAGE TO THE OPTICAL ABSORBER MATERIAL

Damage to the optical absorber material is usually caused by exceeding the manufacturer's specified maximum incident average power density. Refer to the specifications table.

The PRONTO-250-FLEX / EZ series can measure up to 250 W. The beam diameter should always be as large as possible to avoid damaging the absorber. **We recommend using a beam size diameter that covers 70% to 80% of the sensor's aperture.** For the PRONTO, this corresponds to a diameter of 16 mm to 17 mm.

In any case, the beam's incident area should not be less than 10% of the detector's area. Please contact Gentec-EO to make measurements with smaller beams.

The damage threshold decreases with the laser power. Refer to the graphic in Figure 2 for the diameter corresponding to the damage threshold for a Gaussian beam profile. The "minimum 1/e<sup>2</sup> beam diameter" is calculated to obtain a peak intensity 50% lower than the damage threshold and should be considered as the "safe" minimum diameter. If there are "hot spots" in the beam profile, they must be considered in the calculation of the peak intensity.

Damage may also be caused if you use a detector with a contaminated absorber surface. A slight discoloration of the coating may occur, but this does not affect the calibration.

### 4.3 NOT EXCEEDING THE MAXIMUM SENSOR TEMPERATURE

The PRONTO has a built-in thermometer to monitor the sensor's temperature. In order to avoid damaging the sensor, its temperature must not exceed the maximum allowable absorber temperature as in the specification. For temperatures of 25 °C or lower, the thermometer's bulb will be filled as shown on the right-hand side. When making a measurement, the sensor's temperature will gradually rise, and the thermometer icon will fill up too.

If the temperature of the sensor gets close to the acceptable limit, the screen will display the mention "hot" in bold red letters, the thermometer icon will be red, and all functions will be disabled.



If this screen appears, it is essential that you remove the device from the laser beam path and allow it sufficient time to cool before attempting another measurement.



In addition to the built-in thermometer, the PRONTO has a yellow temperature sticker on its rear face. The central part of the sticker turns to black when the temperature of the device exceeds 65 °C (150 °F). This indicates that the detector was probably damaged due to overheating. In this case, contact your local Gentec-EO representative.

#### 4.4 HOW TO PROPERLY HANDLE THE DEVICE

Laser radiation can heat the device very quickly. The entire body of the device can get hot, especially at higher powers. In addition to the standard safety precautions that should be taken when working with laser radiation, we recommend placing the device on an optical stand when making a measurement. For this use, the device is equipped with two mounting holes with an 8-32 thread (see Figure 3).



Figure 8. Recommended setup when making a measurement: install the device on an optical stand before placing it in the laser beam path

Gentec-EO offers a compatible stand for the PRONTO. You can contact your local Gentec-EO representative for the exact model.

It is also possible to place the PRONTO on a horizontal surface and illuminate the sensor from above. The back of the device is flat, so it will stay stable when placed on a horizontal surface.



Figure 9. Recommended setup when making a measurement: install the device flat on a horizontal surface and illuminate from above

## 5. USB COMMUNICATION

### 5.1. DESCRIPTION

The PRONTO has one communication mode: ASCII. The format will require text input commands which follow rules stated in Section 5.3. Section 5.5 describes all the commands.

The USB class used by the PRONTO is a communications device class (CDC). This means it shows up in the host PC as a COM port, but it is not a COM port, rather a true full speed USB port. You can talk to it as if it were an RS232 port, but much faster. Follow the Windows prompts to install the USB drivers. The USB drivers are fully tested and digitally signed by Microsoft.

Open the appropriate port in your software with standard COM port tools. None of the port settings matter since they are not used, so leave them at whatever default they are in. It is a real USB connection.

Use the standard COM port write-and-read protocols to control the PRONTO.

### 5.2. SETTING UP COMMUNICATION TO THE PRONTO

#### 5.2.1. Connect the monitor

Use your favorite serial terminal emulator to connect to the COM port. Some example serial terminal programs are:

- CoolTerm: <https://freeware.the-meiers.org/>
- PuTTY: <http://www.putty.org/>
- RealTerm: <https://realterm.sourceforge.io/>

If you need to know the COM port number, you can find it in the Windows device manager.

Use the following communication parameter settings:

PRONTO COM port settings	
Bits per second	Any setting will work
Data bits	Any setting will work
Parity	Any setting will work
Stop bits	Any setting will work
Flow control	Any setting will work

#### 5.2.2. To echo commands

The commands you type will not appear in the terminal window unless you set up the terminal emulator to do so. Only the response from the monitor will be displayed. If you prefer to see the commands you are typing, enable "local echo" or equivalent setting.

#### 5.2.3. Test the connection

In the terminal window, type \*VER. If the response is the version of your monitor, you are successfully connected and ready for serial command action.



## 5.3. SERIAL COMMAND FORMAT

### 5.3.1. Serial protocol rules

Commands are sent as text strings. The response will either be data or an empty string.

### 5.3.2. Text mode rules

All text commands must begin with a trig character (\*). You do not need to end with a line feed or a carriage return. Parameters must NOT be separated by spaces. Characters do not have to be capitals, mixed upper and lower cases are good. Replies to all text mode commands are also in text mode and end with a carriage return and a line feed.

In case of an error, the reply string is one of the following:

**"Command Error. Command not recognized."**

or

**"Command Error. Command must start with '\*'"**

Because all text mode replies end with a carriage return <CR> or line feed <LF> (or both), a text reply contains tabulations when many elements need to be separated in the string. This is useful when exporting data to a spreadsheet.

#### 5.4. LIST OF SERIAL COMMANDS FOR THE PRONTO (SUMMARY)

#	Command name	Command	Description
<b>Display</b>			
01	Set scale	SCS	Manually sets the scale
02	Set scale up	SSU	Changes scale to the next higher scale
03	Set scale down	SSD	Changes scale to the next lower scale
04	Get current scale index	GCR	Returns scale index between 0 and 41
05	Set autoscale	SAS	Sets the autoscale
06	Get autoscale	GAS	Returns to autoscale status
07	Display valid scale	DVS	Displays the valid scales for the connected head
08	Set trigger level	STL	Sets the internal trigger level for pulse energy
09	Get trigger level	GTL	Returns trigger level value
10	Get measure mode display	GMD	Returns the current measure mode on PRONTO
11	Control LCD	LCD	Turns on/off the LCD
<b>Measurement</b>			
<b>Data acquisition</b>			
12	Query current value	CVU	Gets the value currently in ASCII or binary
13	Send continuous transmission of data	CAU	Sends the values in ASCII or binary to the serial port with the data sampling setting
14	Stop the CAU command	CSU	Stops the *CAU command
15	Query new value ready	NVU	Determines if new reading is available or not
16	Get housing temperature	TMP	Returns the housing temperature
<b>Setup</b>			
17	Set personal wavelength Correction in nm	PWC	Specifies the wavelength in nm
18	Set personal wavelength Correction in microns	PWM	Specifies the wavelength in microns
19	Get wavelength	GWL	Returns the wavelength in nm
<b>Control</b>			
20	Set anticipation	ANT	Turns the anticipation on or off
21	Get anticipation status	GAN	Returns the anticipation status
22	Set zero offset	SOU	Zeroes the reading for a value without offset
23	Clear zero offset	COU	Undoes the zeroing of the reading for a power detector
24	Get zero offset	GZO	Returns the zero offset status
25	Set user multiplier	MUL	Sets the multiplier value
26	Get user multiplier	GUM	Returns the current multiplier value
27	Set user offset	OFF	Sets the offset value
28	Get user offset	GUO	Returns the current offset value
29	Short touch on button	PRS	Simulates a short touch on the button of display
30	Long touch on button	PRL	Simulates a long touch on the button of display
<b>Instrument and detector information</b>			
31	Query version	VER	Gets firmware version of the monitor
32	Query status	STS	Retrieves the detector information and monitor settings
33	Query extended status	ST2	Returns the extended status
34	Return instrument ID	IDN	Returns the device model
35	Return instrument firmware	GSV	Returns the firmware version
36	Return global information	GFW	Returns the firmware identification number, the device model and firmware version.
37	Query battery state	QSO	Returns the battery level

## 5.5. DETAILED DESCRIPTION OF THE SERIAL COMMANDS FOR PRONTO (COMPLETE)

### 5.5.1. Display

#### 01 – Set scale

This command is used to force the display of the current data into a specific scale. The lower scale is always zero, the higher scales can be found in the table below. The autoscale mode applies the best scale for the current values in real time. The parameter must be one of the identifiers in the table below and have two digits.

Command	Parameters	Answer	Model available
SCS	Range index		PRONTO-250-FLEX PRONTO-250-EZ

Range identifiers

Index	Value	Index	Value
00	1 picowatt or picojoule	21	30 milliwatts or millijoules
01	3 picowatts or picojoules	22	100 milliwatts or millijoules
02	10 picowatts or picojoules	23	300 milliwatts or millijoules
03	30 picowatts or picojoules	24	1 watt or joule
04	100 picowatts or picojoules	25	3 watts or joules
05	300 picowatts or picojoules	26	10 watts or joules
06	1 nanowatt or nanojoule	27	30 watts or joules
07	3 nanowatts or nanojoules	28	100 watts or joules
08	10 nanowatts or nanojoules	29	300 watts or joules
09	30 nanowatts or nanojoules	30	1 kilowatt or kilojoule
10	100 nanowatts or nanojoules	31	3 kilowatts or kilojoules
11	300 nanowatts or nanojoules	32	10 kilowatts or kilojoules
12	1 microwatt or microjoule	33	30 kilowatts or kilojoules
13	3 microwatts or microjoules	34	100 kilowatts or kilojoules
14	10 microwatts or microjoules	35	300 kilowatts or kilojoules
15	30 microwatts or microjoules	36	1 megawatt or megajoule
16	100 microwatts or microjoules	37	3 megawatts or megajoules
17	300 microwatts or microjoules	38	10 megawatts or megajoules
18	1 milliwatt or millijoule	39	30 megawatts or megajoules
19	3 milliwatts or millijoules	40	100 megawatts or megajoules
20	10 milliwatts or millijoules	41	300 megawatts or megajoules

**Default:** Autoscale



#### Example

The following example sets the scale to 30 watts or joules.

Command: \*SCS27

Answer:

#### 02 – Set scale up

This command is used to force the display of the current data into a higher scale.

Command	Parameters	Answer	Model available
SSU	None		PRONTO-250-FLEX PRONTO-250-EZ



### 07 – Display valid scale

This command is used to display all the valid scales that the connected head supports. The scales are displayed in the scale index. Please refer to the set scale section for the table correspondence.

Command	Parameters	Answer	Model available
DVS	None	The valid scale index	PRONTO-250-FLEX PRONTO-250-EZ

The following example is for a PRONTO-250-FLEX which can have the following scales:

- 1 J
- 3 J
- 10 J
- 30 J
- 100 J
- 300 J



#### Example

```
Command: *DVS
Answer: [24]: 1.000<CR><LF>
        [25]: 3.000<CR><LF>
        [26]: 10.00<CR><LF>
        [27]: 30.00<CR><LF>
        [28]: 100.0<CR><LF>
        [29]: 300.0<CR><LF>
```

### 08 – Set trigger level

This command sets the internal trigger level when using the device in energy mode.

Command	Parameters	Answer	Model available
STL	Trigger level (in percentage) must be four numerical values		PRONTO-250-FLEX PRONTO-250-EZ

**Default:** 2%

The value should be set between 0.1 and 99.9.



#### Example

```
Command: *STL15.4 (15.4%)
        *STL00.2 (0.2%)
Answer:
```



## 5.5.2. Data acquisition

### 12 – Query current value

This command is used to query the value that is currently being displayed by the monitor. The value is displayed in watts or in joules.

Command	Parameters	Answer	Model available
CVU	None	Data in ASCII (scientific notation)	All



#### Examples

For example, a 506.601 watts reading and a -12.25631 milliwatts reading would be displayed as shown below.

```
Command: *CVU           Answer:  +5.066010e+02<CR><LF>
Command: *CVU           Answer:  -1.225631e-02<CR><LF>
```

### 13 – Send continuous transmission of data

This command is used to send data to the serial port at a frequency of 6.8 Hz in CWP mode.

Command	Parameters	Answer	Model available
CAU	None	Data in ASCII (scientific notation)	All



#### Examples

For example, with a PRONTO in CWP, a reading around 5.0 watts would be displayed as shown below until the command \*CSU is sent.

```
Command: *CAU           Answer:
                        +5.066010e+00<CR><LF>
                        +5.066012e+00<CR><LF>
                        +5.066014e+00<CR><LF>
                        +5.066022e+00<CR><LF>
                        +5.066032e+00<CR><LF>
                        +5.066042e+00<CR><LF>
                        ...
```

### 14 – Stop the CAU command

This command is used to stop the real-time transfer enabled by the CAU command.

Command	Parameters	Answer	Model available
CSU	None		All

### 15 – Query new value ready

This command is used to check whether a new value is available from the device. Though optional, its use is recommended when used with a single pulse operation.

Command	Parameters	Answer	Model available
NVU	None	New data available or New data not available	All



#### Example

Command: \*NVU

Answer: New data not available <CR><LF>

### 16 – Send temperature of detector

This command is used to send temperature data to the serial port, according to the data sampling rate. To use the TMP1 command, the CAU command needs to be activated. Using the TMP1 command will send the temperature at the same rate as CAU command. The first number is the measured power, and the second number is the measured temperature. TMP0 will send a single value of the detector temperature.

Command	Parameters	Answer	Model available
TMP	0.1	Data in ASCII	All



#### Examples

For example, with a wattmeter, a reading around 5.0 watts would be displayed as shown below until the command \*CSU is sent.

Command: \*CAU and \*TMP1      Answer:  
+5.066010e+00, 23.1 <CR><LF>  
+5.066012e+00, 23.2 <CR><LF>  
+5.066014e+00, 23.2 <CR><LF>

Command: \*TMP0                  Answer:  
23.0 <CR><LF>



### 5.5.3. Setup

#### 17 – Set personal wavelength correction in nm

This command is used to specify the wavelength in nm being used on the detector. The internal memory in the detector contains measured spectral data for a wide range of wavelengths. A valid value is set between the lowest and highest wavelengths supported by the device, and it should not be a floating point value. The input parameter must have five digits. If the desired wavelength does not have five digits, you must enter a zero-padded number. For example, to set the wavelength at 514 nm, you must enter 00514 or 514.0.

Specifying zero as a wavelength or providing an out-of-bound value as a parameter cancels the command.

Command	Parameters	Answer	Model available
PWC	Wavelength		All

**Default:** Calibration wavelength (typically 1064 nm, varies with the detector model)



#### Example

The following example sets the wavelength to 1550 nm.

Command: \*PWC01550

Answer:

#### 18 – Set personal wavelength correction in microns

This command is used to specify the wavelength in microns. The internal memory in the detector contains measured spectral data for a wide range of wavelengths. A valid value is set between the lowest and highest wavelengths supported by the device. The input parameter must have five digits and can be a floating point value. If the desired wavelength does not have five digits, you must enter a zero-padded number. For example, to set the wavelength at 10.60 microns, you must enter 010.6.

Specifying zero as a wavelength or providing an out-of-bound value as a parameter cancels the command.

Command	Parameters	Answer	Model available
PWM	Wavelength		All

**Default:** Calibration wavelength (typically 1064 nm, varies with the detector model)



#### Example

The following example sets the wavelength to 2.5 microns (2500 nm).

Command: \*PWM02.50

Answer:

## 19 – Get wavelength

This command returns the wavelength in nm.

Command	Parameters	Answer	Model available
GWL	None	Returns the wavelength in nm	All



### Example

Command: \*GWL

Answer: PWC: 1064<CR><LF>

## 5.5.4. Control

### 20 – Set anticipation

This command is used to enable or disable the anticipation processing when the device is reading. The anticipation is a software-based acceleration algorithm that provides faster readings using the detector's calibration.

Command	Parameters	Answer	Model available
ANT	1: on 0: off		All

Default: On



### Example

The following example sets the anticipation on.

Command: \*ANT1

Answer:

### 21 – Get anticipation status

This command returns the anticipation status. If the anticipation is not available, it will always be turned off.

Command	Parameters	Answer	Model available
GAN	None	1: on 0: off	All



### Example

Command: \*GAN

Answer: Anticipation: 0<CR><LF>



\*MUL2.500000

## 26 – Get user multiplier

This command returns the multiplier value.

Command	Parameters	Answer	Model available
GUM	None	Current multiplier value	All



### Example

Command: \*GUM

Answer:  
User multiplier: 2.5000000E+00<CR><LF>

## 27 – Set user offset

This command is used to set the value of the offset.

Command	Parameters	Answer	Model available
Off	Eight-character numerical value		All

Default: 0



### Example

The following example sets the offset to 1.5 watts or 1.5 joules.

Command: \*OFF1.500000                      Answer:  
          or  
          \*OFF1.500e+0

The other option available is the zero offset. The zero offset operation is done first, before the user multipliers and offsets.

## 28 – Get user offset

This command returns the offset value.

Command	Parameters	Answer	Model available
GUO	None	Current offset value	All



### Example

Command: \*GUO

Answer:  
User offset: 1.5000000E+00<CR><LF>

### 29 – Short touch on button

This command is used to simulate a short touch on any button shown on the display and the home button. Each button is numbered from 1 to 7, and they are ordered like a book, from the left to right and top to bottom. The number 0 is reserved to control the home button.

**Note:** This command is only supported for the following example.

Command	Parameters	Answer	Model available
PRS	0,1,2,3,4,5,6,7	ACK or NACK	All



#### Example

The following example shows how to get the device ready for a measurement and how to save data.

Command: \*PRS1 from the main menu

Answer: ACK



#### Example

The following example shows how to save data.

Command: \*PRS2 from the main menu

Answer: ACK



**Example**

The next example shows how to change the mode using the following sequence (for PRONTO-250-FLEX / EZ).

Command: \*PRS0 from the main menu

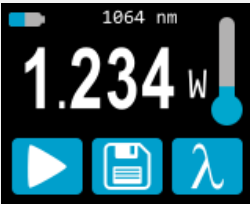

Answer: ACK



\*PRS4 from the main menu



Answer: ACK



Then use PRS with one of the following numbers:

PRS1=SSP  
PRS2=CWP  
PRS3=SSE

**30 – Long touch on button**

This command is used to simulate a long touch of 3 seconds on any button shown on the display and on the home button. Each button is numbered from 1 to 7, and they are ordered like a book, from the left to right and top to bottom. The number 0 is reserved to control the home button.

**Note:** This command is only supported for the following example.

Command	Parameters	Answer	Model available
PRL	0,1,2,3,4,5,6,7	ACK or NACK	All



**Example**

Command: \*PRL0 from any menu

Answer: ACK (PRONTO shut down)

\*PRL2 from the main menu

ACK (erase data, see Section 2.6.3)

### 5.5.5. Instrument and detector information

#### 31 – Query version

This command is used to query the device to get information about the firmware version and the device type.

Command	Parameters	Answer	Model available
VER	None	Version and device type	All



#### Example

Command: \*VER

Answer: PRONTO-FLEX version 1.00.04 <CR><LF>

#### 32 – Query status

This command is used to query the device to get information about the following characteristics:

- Measure mode
- Maximum, minimum, and current scale
- Maximum, minimum, and current wavelength with and without attenuation
- Attenuator availability and status
- Detector model
- Detector serial number

Command	Parameters	Answer	Model available
STS	None	A hexadecimal structure described in the table below	All

The first byte represents the validity of the structure: 0 represents a valid line while 1 is the end of the structure. The next 4 bytes represent the address line, and the last 4 bytes are the actual value. The values are written on 32 bits, which means that all the values are written on two lines. The first line represents the LSB, and the second line represents the MSB.

The following table shows the output with a PRONTO-50-W5, serial number 199672.

Note that text data values such as detector name and serial number are in ASCII-encoded little-endian 16-bit chunks. The byte order must be reversed to be converted into a readable format.

Hexadecimal structure			Converted value	Definition
Valid	Address	Value		
:0	0000	0003	3	Reserved
:0	0001	0000	0	Reserved
:0	0002	0003	3	Reserved
:0	0003	0000	0	Reserved
:0	0004	0000	0	Measure mode LSB
:0	0005	0000	0	Measure mode MSB
:0	0006	0015	21	Current scale LSB (refer to scale index *SCS)
:0	0007	0000	0	Current scale MSB (refer to scale index *SCS)
:0	0008	0019	25	Maximum scale LSB (refer to scale index *SCS)
:0	0009	0000	0	Maximum scale MSB (refer to scale index *SCS)
:0	000A	0011	17	Minimum scale LSB (refer to scale index *SCS)
:0	000B	0000	0	Minimum scale MSB (refer to scale index *SCS)
:0	000C	0428	1064	Current wavelength LSB (nm)
:0	000D	0000	0	Current wavelength MSB (nm)
:0	000E	2968	10600	Maximum wavelength LSB (nm)
:0	000F	0000	0	Maximum wavelength MSB (nm)

Hexadecimal structure			Converted value	Definition
Valid	Address	Value		
:0	0010	00C1	193	Minimum wavelength LSB (nm)
:0	0011	0000	0	Minimum wavelength MSB (nm)
:0	0012	0001	1	Is the attenuator available LSB (1= yes 0 = no)
:0	0013	0000	0	Is the attenuator available MSB (1= yes 0 = no)
:0	0014	0000	0	Is the attenuator on LSB (1= yes 0 = no)
:0	0015	0000	0	Is the attenuator on MSB (1= yes 0 = no)
:0	0016	2968	10600	Maximum wavelength with attenuation LSB (nm)
:0	0017	0000	0	Maximum wavelength with attenuation MSB (nm)
:0	0018	00C1	193	Minimum wavelength with attenuation LSB (nm)
:0	0019	0000	0	Minimum wavelength with attenuation MSB (nm)
:0	001A	52 50	R P	Detector name in ASCII (PRONTO-50-W5)
:0	001B	4E 4F	N O	
:0	001C	4F 54	O T	
:0	001D	35 2D	5 -	
:0	001E	2D 30	- 0	
:0	001F	35 57	5 W	
:0	0020	32 00		
:0	0021	CC 00		00 = null termination character  Bytes reserved for longer detector names May contain invalid data
:0	0022	CC CC		
:0	0023	CC CC		
:0	0024	CC CC		
:0	0025	CC CC		
:0	0026	CC CC		
:0	0027	CC CC		
:0	0028	CC CC		
:0	0029	CC CC		
:0	002A	39 31	9 1	
:0	002B	36 39	6 9	Detector serial number in ASCII (199672)
:0	002C	32 37	2 7	
:0	002D	00 00		
:0	002E	00 00		00 = null termination character
:1	0000	00 00		End of structure

### 33 – Query extended status

This command is used to query the device to get information about the following characteristics:

- Measure mode
- Maximum, minimum, and current scale
- Maximum, minimum, and current wavelength with and without attenuation
- Attenuator availability and status
- Detector model
- Detector serial number
- Trigger level (0.1 to 99.9)
- Autoscale mode
- Anticipation mode
- Zero offset mode
- User multiplier
- User offset



Command	Parameters	Answer	Model available
ST2	None	A hexadecimal structure described in the table below	All

The first byte represents the validity of the structure: 0 represents a valid line while 1 is the end of the structure. The next 4 bytes represent the address line, and the last 4 bytes are the actual value. The values are written on 32 bits, which means that all the values are written on two lines. The first line represents the LSB, and the second line represents the MSB.

The following table shows the output with a PRONTO-50-W5, serial number 199672.

Note that text data values such as detector name and serial number are in ASCII-encoded little-endian 16-bit chunks. The byte order must be reversed to be converted into a readable format.

Hexadecimal structure			Converted value	Definition
Valid	Address	Value		
:0	0000	3	3	Reserved
:0	0001	0	0	Reserved
:0	0002	3	3	Reserved
:0	0003	0	0	Reserved
:0	0004	0	0	Measure mode LSB
:0	0005	0	0	Measure mode MSB
:0	0006	11	17	Current scale LSB (refer to scale index *SCS)
:0	7	0	0	Current scale MSB (refer to scale index *SCS)
:0	0008	19	25	Maximum scale LSB (refer to scale index *SCS)
:0	0009	0	0	Maximum scale MSB (refer to scale index *SCS)
:0	000A	11	17	Minimum scale LSB (refer to scale index *SCS)
:0	000B	0	0	Minimum scale MSB (refer to scale index *SCS)
:0	000C	428	1064	Current wavelength LSB (nm)
:0	000D	0	0	Current wavelength MSB (nm)
:0	000E	2968	10600	Maximum wavelength LSB (nm)
:0	000F	0	0	Maximum wavelength MSB (nm)
:0	0010	00C1	193	Minimum wavelength LSB (nm)
:0	0011	0	0	Minimum wavelength MSB (nm)
:0	0012	1	1	Is the attenuator available LSB (1= yes 0 = no)
:0	0013	0	0	Is the attenuator available MSB (1= yes 0 = no)
:0	0014	0	0	Is the attenuator on LSB (1= yes 0 = no)
:0	0015	0	0	Is the attenuator on MSB (1= yes 0 = no)
:0	0016	2968	10600	Maximum wavelength with attenuation LSB (nm)
:0	0017	0	0	Maximum wavelength with attenuation MSB (nm)
:0	0018	00C1	193	Minimum wavelength with attenuation LSB (nm)
:0	0019	0	0	Minimum wavelength with attenuation MSB (nm)
:0	001A	52 50	R P	Detector name in ASCII (PRONTO-50-W5)
:0	001B	4E 4F	N O	
:0	001C	4F 54	O T	
:0	001D	35 2D	5 -	
:0	001E	2D 30	- 0	
:0	001F	35 57	5 W	
:0	0020	32 00		00 = null termination character Bytes reserved for longer detector names May contain invalid data
:0	0021	CC 00		
:0	0022	CC CC		
:0	0023	CC CC		
:0	0024	CC CC		
:0	0025	CC CC		
:0	0026	CC CC		
:0	0027	CC CC		
:0	0028	CC CC		
:0	0029	CC CC		



### 36 – Return instrument global information

This command is used to getting general information about the device. This information is included in the previous commands. The information is the identification number of the firmware, the device model and the firmware version.

Command	Parameters	Answer	Model available
GFW	None	Version and device type	All



#### Example

Command: \*GFW

Answer: 104233, PRONTO-FLEX 1.00.04-RC5  
<CR><LF>

### 37 – Query battery state

This command is used to get the battery power in percentages.

Command	Parameters	Answer	Model available
QSO	None	Number in percentages	All



#### Example

Command: \*QSO

Answer: 98 <CR><LF>

### 5.5.6. Error messages

#	Error	Comment
1	Command error. Command not recognized.	Command is invalid.
2	Command error. Command must start with '*'	All text commands must begin with a trig character (*).

## 6. USB DRIVER INSTALLATION

PRONTO USB drivers will install a virtual COM port on your PC. Please download the USB driver at: <https://gentec-eo.com/downloads>.

1. Do not connect the PRONTO to your computer
2. Follow the installation steps until you have the message that the PRONTO is ready to use.

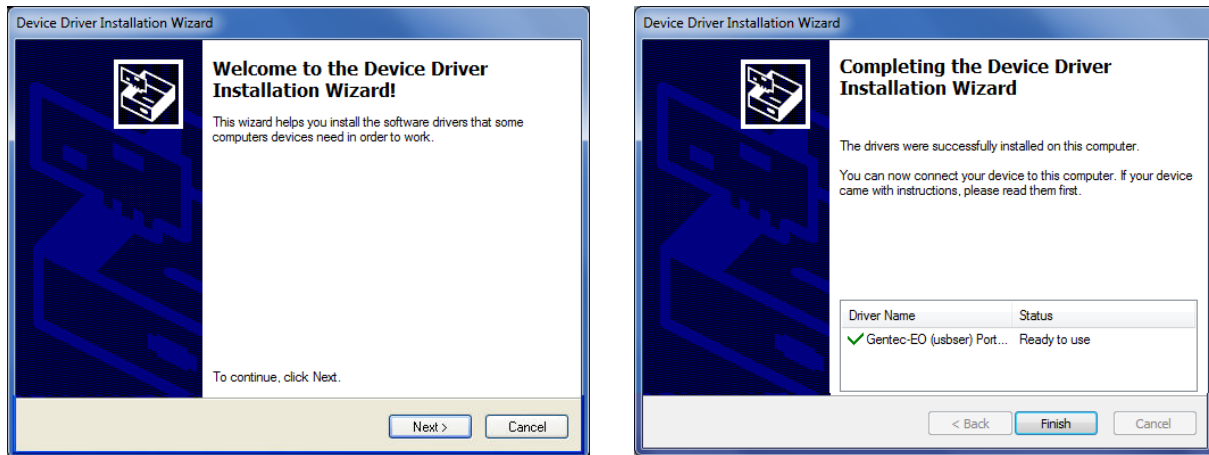

3. You can now connect the PRONTO and install the software.

## 7. MAINTENANCE

### 7.1. FREE FIRMWARE UPGRADE

As new and improved versions of the device firmware are created, it is in your best interest to update your PRONTO. The latest device firmware can be downloaded from the Gentec-EO website at <https://gentec-eo.com/downloads>. Go to the downloads section. Find the file that corresponds to your PRONTO and follow our simple, easy-to-use instructions.

### 7.2. PRONTO-250 EZ ABSORBER CLEANING

The absorber of the PRONTO-250 EZ is easily cleanable as opposed to the PRONTO-250-FLEX absorber. Follow these steps in order to clean the EZ absorber:

- Step 1: Soak an optical cloth with isopropanol.
- Step 2: Gently rub the isopropanol-soaked optical cloth on Absorber EZ.
- Step 3: Dry Absorber EZ with an air jet.

## 8. DECLARATION OF CONFORMITY



Application of Council Directive(s): 2014/30/EU EMC Directive

Manufacturer's Name: Gentec Electro Optics, Inc.  
 Manufacturer's Address: 445, St-Jean Baptiste, Suite 160  
 Québec (Québec) G2E 5N7  
 Canada

European Representative Name: Laser Components S.A.S.  
 Representative's Address: 45 bis Route des Gardes  
 92190 Meudon (France)

Type of Equipment: Optical Power Monitor  
 Model No.: PRONTO Series  
 Year of test & manufacture: 2015

Standard(s) to which Conformity is declared:

### Emissions

Product Standard	Test Standard	Description
EN 61326-1_Ed2:2013 (IEC 61326-1_Ed2:2012)	CISPR 11:+A1:2010 Class A	Radiated Emissions
EN 61326-1_Ed2:2013 (IEC 61326-1_Ed2:2012)	Radiated Emissions FCC part 15 2013) subpart B	Radiated Emissions

### Immunity

Product Standard	Test Standard	Description	Performance Criteria
EN 61326-1_Ed2:2013 (IEC 61326-1_Ed2:2012)	IEC 61000-4-2:2008Ed.2	Electrostatic discharge immunity	Criteria B
EN 61326-1_Ed2:2013 (IEC 61326-1_Ed2:2012)	IEC 61000-4-3:2006+ A1:2007+A2:2010	RF Conducted Immunity	Criteria A

I, the undersigned, hereby declare that the equipment specified above conforms to the above Directive(s) and Standard(s).

Place: Québec (Québec)

Date: 7 July, 2015

(President)

## 9. UKCA DECLARATION OF CONFORMITY

Application of Council Directive(s): 2014/30/EU EMC Directive



Manufacturer's Name: Gentec Electro Optics, Inc.  
 Manufacturer's Address: 445, St-Jean Baptiste, Suite 160  
 Québec (Québec) G2E 5N7  
 Canada

European Representative Name: Laser Components S.A.S.  
 Representative's Address: 45 bis Route des Gardes  
 92190 Meudon (France)

Type of Equipment: Optical Power Monitor  
 Model No.: PRONTO Series  
 Year of test & manufacture: 2015

Standard(s) to which Conformity is declared:

### Emissions

Product Standard	Test Standard	Description
EN 61326-1_Ed2:2013 (IEC 61326-1_Ed2:2012)	CISPR 11:+A1:2010 Class A	Radiated Emissions
EN 61326-1_Ed2:2013 (IEC 61326-1_Ed2:2012)	Radiated Emissions FCC part 15 2013) subpart B	Radiated Emissions

### Immunity

Product Standard	Test Standard	Description	Performance Criteria
EN 61326-1_Ed2:2013 (IEC 61326-1_Ed2:2012)	IEC 61000-4-2:2008Ed.2	Electrostatic Discharge Immunity	Criteria B
EN 61326-1_Ed2:2013 (IEC 61326-1_Ed2:2012)	IEC 61000-4-3:2006+ A1:2007+A2:2010	RF Conducted Immunity	Criteria A

I, the undersigned, hereby declare that the equipment specified above conforms to the above Directive(s) and Standard(s).

Place: Québec (Québec)

Date: December 1, 2021

## 10. APPENDIX A – WEEE DIRECTIVE

### Recycling and separation procedure for WEEE directive 2012/19/EU

This section is used by the recycling center when the detector reaches the end of its life. Removing the insulation or troubling the inside of the monitor will void the detector warranty.

The complete detector contains:

- 1 detector
- 1 cable
- 1 calibration certificate

### Separation

Paper: certificate  
Printed circuit board: inside the detector  
Aluminum: detector casing  
Plastic: parts inside the detector  
Li-ion cell: battery

## 11. APPENDIX B – INSTALLING THE PRONTODATATRANSFER SOFTWARE

1. Download and install the driver from our website.
2. Download the software file from our website.
3. Double-click the .exe file to start the installer.



4. Choose the folder for the installation and click next until the installation is complete. Then click close.

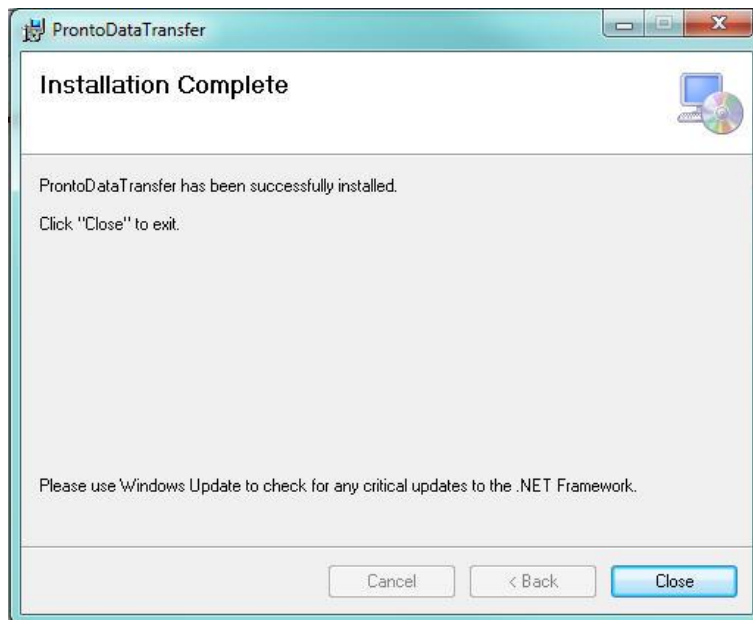



5. Once the software is installed, locate it on your computer and start the program by clicking the

ProntoDataTransfer icon .

6. A download window appears with a download file button.

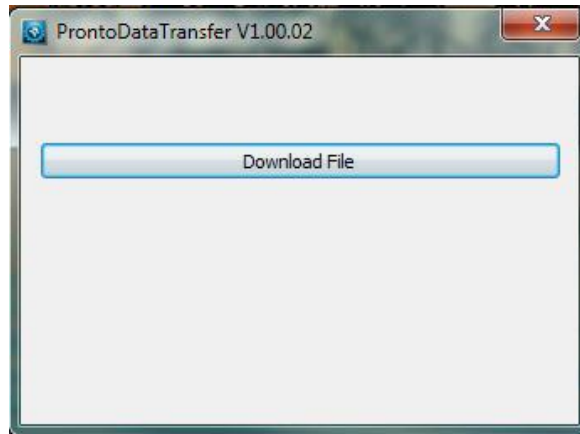

7. Click the download file button and select a known folder on your computer where you will save the data. Do not forget to also enter a file name. The file format is .txt.

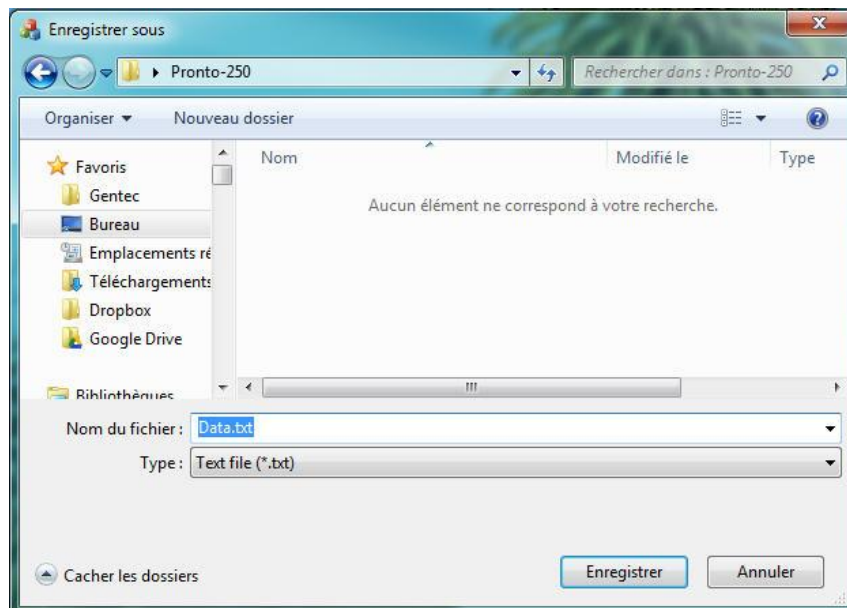

8. You can now open and analyze the data in your preferred data analysis software.

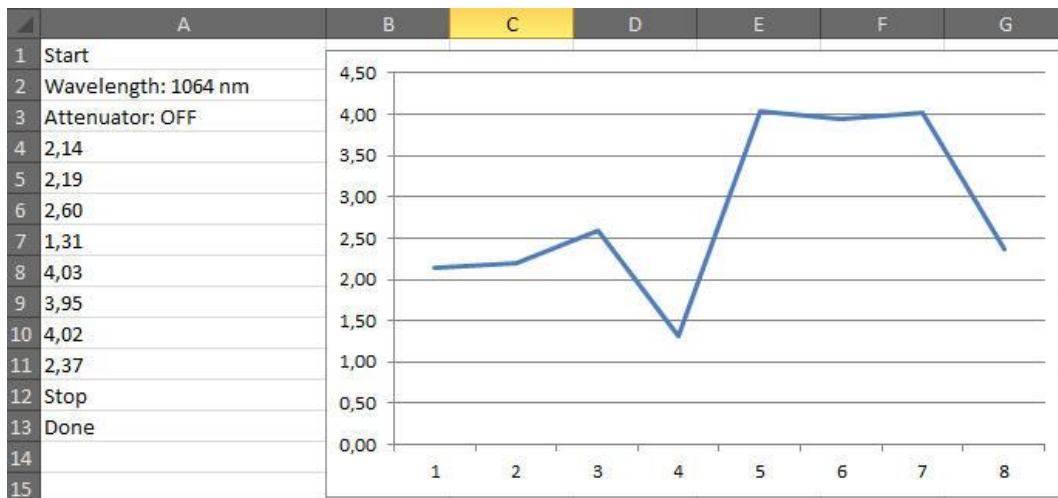

## 12. APPENDIX C – UPDATING THE PRONTO FIRMWARE

1. Before updating the firmware, transfer any saved data using the ProntoDataTransfer software.
2. Download the executable from our website.
3. Plug your PRONTO to your computer using a USB cable.



### Warning

Do not unplug the PRONTO or turn off your computer while you are updating your device.

4. Double-click the EXE file to start the updater. Click yes to begin the update.

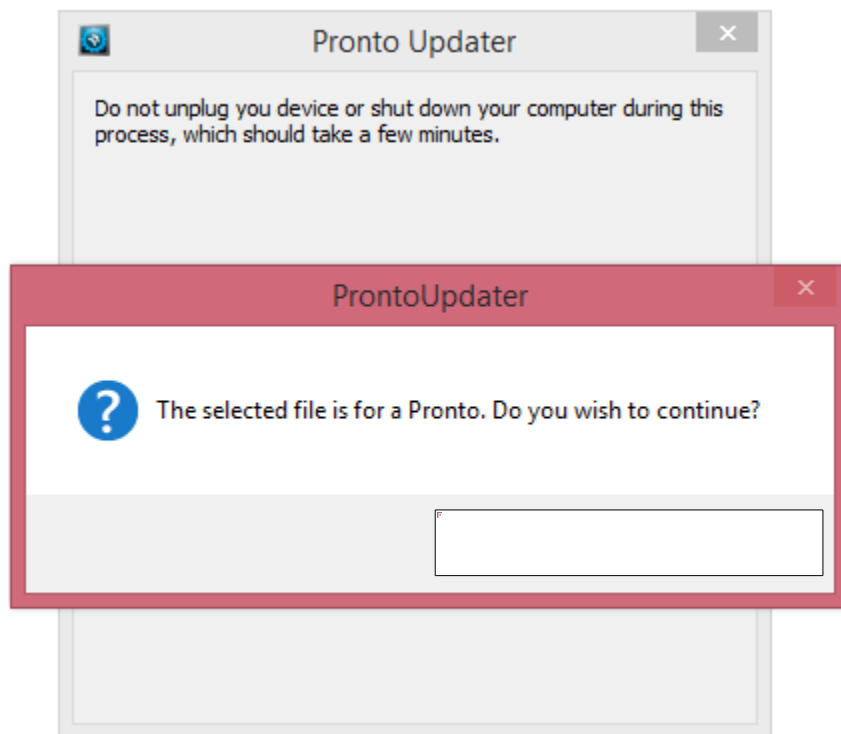

5. Once the update is done, you can unplug your device and continue using your PRONTO as usual.

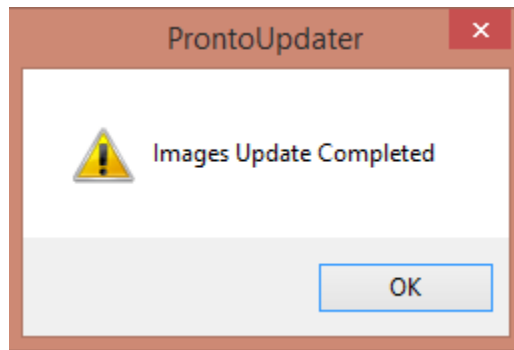

# LEADER IN LASER BEAM MEASUREMENT SINCE 1972



POWER & ENERGY METERS



BEAM PROFILING



THZ MEASUREMENT

## CANADA

445 St-Jean-Baptiste, Suite 160  
Quebec, QC, G2E 5N7  
CANADA

T (418) 651-8003  
F (418) 651-1174

[info@gentec-eo.com](mailto:info@gentec-eo.com)

## UNITED STATES

5825 Jean Road Center  
Lake Oswego, OR, 97035  
USA

T (503) 697-1870  
F (503) 697-0633

[info@gentec-eo.com](mailto:info@gentec-eo.com)

## JAPAN

Office No. 101, EXL111 building,  
Takinogawa, Kita-ku, Tokyo  
114-0023, JAPAN

T +81-3-5972-1290  
F +81-3-5972-1291

[info@gentec-eo.com](mailto:info@gentec-eo.com)

## CALIBRATION CENTERS

- 445 St-Jean-Baptiste, Suite 160  
Quebec, QC, G2E 5N7, CANADA
- Werner von Siemens Str. 15  
82140 Olching, GERMANY
- Office No. 101, EXL111 building,  
Takinogawa, Kita-ku, Tokyo  
114-0023, JAPAN